

groov RIO
USER'S GUIDE

groov RIO USER'S GUIDE

for
GRV-R7-MM1001-10

Form 2324-200610 – June 2020

OPTO 22
The Future of Automation.

43044 Business Park Drive • Temecula • CA 92590-3614
Phone: 800-321-OPTO (6786) or 951-695-3000
Fax: 800-832-OPTO (6786) or 951-695-2712
www.opto22.com

Product Support Services
800-TEK-OPTO (835-6786) or 951-695-3080
Fax: 951-695-3017
Email: support@opto22.com
Web: support.opto22.com

groov RIO User's Guide
Form 2324-200610 — June 2020

Copyright © 2020 Opto 22.

All rights reserved.

Printed in the United States of America.

The information in this manual has been checked carefully and is believed to be accurate; however, Opto 22 assumes no responsibility for possible inaccuracies or omissions. Specifications are subject to change without notice.

Opto 22 warrants all of its products to be free from defects in material or workmanship for 30 months from the manufacturing date code. This warranty is limited to the original cost of the unit only and does not cover installation, labor, or any other contingent costs. Opto 22 I/O modules and solid-state relays with date codes of 1/96 or newer are guaranteed for life. This lifetime warranty excludes reed relay modules, *groov* and SNAP serial communication modules, SNAP PID modules, and modules that contain mechanical contacts or switches. Opto 22 does not warrant any product, components, or parts not manufactured by Opto 22; for these items, the warranty from the original manufacturer applies. Refer to Opto 22 form 1042 for complete warranty information.

Wired+Wireless controllers and brains are licensed under one or more of the following patents: U.S. Patent No(s). 5282222, RE37802, 6963617; Canadian Patent No. 2064975; European Patent No. 1142245; French Patent No. 1142245; British Patent No. 1142245; Japanese Patent No. 2002535925A; German Patent No. 60011224.

Opto 22 FactoryFloor, *groov*, *groov* EPIC, *groov* RIO, mobile made simple, Optomux, and Pamux are registered trademarks of Opto 22. Generation 4, *groov* Server, ioControl, ioDisplay, ioManager, ioProject, ioUtilities, *mistic*, Nvio, Nvio.net Web Portal, OptoConnect, OptoControl, OptoDataLink, OptoDisplay, OptoEMU, OptoEMU Sensor, OptoEMU Server, OptoOPCServer, OptoScript, OptoServer, OptoTerminal, OptoUtilities, PAC Control, PAC Display, PAC Manager, PAC Project, PAC Project Basic, PAC Project Professional, SNAP Ethernet I/O, SNAP I/O, SNAP OEM I/O, SNAP PAC System, SNAP Simple I/O, SNAP Ultimate I/O, and Wired+Wireless are trademarks of Opto 22.

ActiveX, JScript, Microsoft, MS-DOS, VBScript, Visual Basic, Visual C++, Windows, and Windows Vista are either registered trademarks or trademarks of Microsoft Corporation in the United States and other countries. Linux is a registered trademark of Linus Torvalds. ARCNET is a registered trademark of Datapoint Corporation. Modbus is a registered trademark of Schneider Electric, licensed to the Modbus Organization, Inc. Wiegand is a registered trademark of Sensor Engineering Corporation. Allen-Bradley, CompactLogix, ControlLogix, MicroLogix, SLC, and RSLogix are either registered trademarks or trademarks of Rockwell Automation. CIP and EtherNet/IP are trademarks of ODVA. Raspberry Pi is a trademark of the Raspberry Pi Foundation. The registered trademark Ignition by Inductive Automation® is owned by Inductive Automation and is registered in the United States and may be pending or registered in other countries. CODESYS® is a registered trademark of 3S-Smart Software Solutions GmbH.

groov includes software developed by the OpenSSL Project for use in the OpenSSL Toolkit. (<http://www.openssl.org>)

All other brand or product names are trademarks or registered trademarks of their respective companies or organizations.

Opto 22
Automation Made Simple.

Table of Contents

Chapter 1: Welcome	1
Welcome to <i>groov</i> RIO!	1
<i>groov</i> RIO as Edge I/O	2
<i>groov</i> RIO as Remote I/O in an Opto 22 Control System	3
<i>groov</i> RIO with Modbus/TCP or Custom PC-based Control Programs	4
Requirements	5
Power Requirements	5
Field Device Wiring	5
Software Requirements	5
About This Guide	5
What's In This Guide?	5
Service and Maintenance	6
Service (Product Support)	6
Chapter 2: Mounting and Connecting a <i>groov</i> RIO	7
Gathering your Equipment and Information	7
Familiarizing Yourself with <i>groov</i> RIO	7
Mounting	9
Mounting on DIN Rail	9
Mounting on a Panel	10
Connecting Field Devices	11
Wiring Field Devices to <i>groov</i> RIO	11
Connecting Power Supply	12
External Power Source or Supply	12
Power Over Ethernet	13
Chapter 3: Initializing a <i>groov</i> RIO	15
Chapter 4: Navigating <i>groov</i> Manage	19
Understanding the Page Navigation Aids	19
Learning How Information is Organized in <i>groov</i> Manage	20
Navigating Through <i>groov</i> Manage on a Computer or Mobile Device	20
Finding Information About I/O Channels	20
Chapter 5: Controlling Access to <i>groov</i> RIO	23

Part of an Overall Security System.....	23
Creating User IDs and Configuring Their Access	23
Choosing Access Levels for Users	23
Creating User IDs	24
Managing the SSL Security Features of your <i>groov</i> RIO	24
Learning How SSL Works on <i>groov</i> RIO	24
Creating a Self-Signed Certificate	24
Switching to a CA-signed Certificate	25
Uploading a Public Key Certificate	26
Changing SSL Security Features for Sparkplug	26
Configuring the Firewall.....	27
Creating a Firewall Rule	28
Changing a Firewall Rule	29
Chapter 6: Connecting <i>groov</i> RIO to a Network or Multiple Networks	33
Reviewing RIO's Network Capabilities and Default Settings.....	34
Understanding RIO's Default Network Configuration	35
Initializing with a Wired Connection	36
Keeping Networks Separate	36
Reviewing Your Network Requirements	36
Collecting Network Configuration Information	38
Collecting Information for Automatic Connections	38
Collecting Information for Manual Connections	39
Collecting Network Configuration Information for OpenVPN Connection	40
Configuring the Network Interfaces.....	42
Configuring ETH0	42
Configuring WLAN0	43
Saving the Configuration.....	44
Connecting to a Virtual Private Network (VPN).....	44
Testing the Network Connections and Fine-Tuning Security.....	46
Chapter 7: Configuring a <i>groov</i> RIO	47
Setting and Adjusting Date, Time, and Time Zones	47
Setting the Date and Time Manually	48
Setting the Date, Time, and Time Zone by Synchronizing with Time Servers	48
Setting the Time and Time Zone by Selecting a Location	49
Managing The USB Port	49
Connecting Serial Devices.....	49
Device Name and Port Number	50
Finding Device Names and Port Numbers	50
Attaching and Detaching a USB Storage Device	51
Requirements for USB Storage Devices	51
Understanding How <i>groov</i> RIO Handles USB Storage Devices	51
Reviewing Security Issues with USB Storage Devices	51
Disabling Access to USB Storage Devices	51
Attaching a USB Storage Device	52
Detaching a USB Storage Device	53
Copying, Moving, or Downloading a File on a USB Storage Device	54

Installing an Approved USB WiFi Adapter.....	55
Enabling Node-RED	56
Uploading Files to RIO's Internal File System or USB Storage Device.....	56
Chapter 8: Configuring I/O	59
Selecting Functions, Signals, and Features.....	59
Selecting a Method for Configuring I/O	60
Configuring I/O Through groov Manage.....	60
Configuring I/O Through CODESYS Development System.....	63
Checking Compatibility Between Library Package, Development System, and Firmware	64
Adding a <i>groov</i> RIO to a CODESYS Project	66
Adding Channels and Selecting Signal Types (Plugging in Devices)	67
Changing Signal Types (Updating Devices)	67
Setting Features (Configuring Object Parameters)	67
Understanding How Quality Errors are Reported	70
Viewing Information About a Quality Error	70
Chapter 9: Enabling MQTT	71
What is MQTT?.....	71
MQTT on <i>groov</i> RIO	71
Configuring and Enabling MQTT with String Payloads.....	72
Collecting Information	72
Configuring and Enabling MQTT Service	73
Configuring and Enabling MQTT with Sparkplug Payloads from <i>groov</i> RIO.....	75
Collecting Information	75
Configuring and Enabling MQTT Service	76
Chapter 10: Developing Node-RED Flows	79
For Experienced Node-RED Developers.....	79
Learning about Node-RED on RIO.....	79
Learning to Develop a Node-RED Flow.....	80
Opening the Node-RED Editor	80
Creating a Flow	81
Deploying the Flow and Testing It	82
Adding a Function Node	82
Installing <i>groov</i> I/O Nodes	83
Installing <i>groov</i> View Nodes to Access Data Stores	85
Installing Opto 22 PAC Control Nodes	86
Chapter 11: Maintaining a <i>groov</i> RIO	91
Backing up Your <i>groov</i> RIO Settings	91
Restoring a Backup or Specific Settings from a Backup File	93
Updating Firmware on a <i>groov</i> RIO.....	96
Troubleshooting	99
Browser Reports that URL to RIO is Unreachable	99
CODESYS: "Invalid Channel Type. Module or channel may not be compatible."	101
Resetting to Factory Defaults	102

Collecting Information for Product Support	103
Conducting an OptoSupport Remote Support Service (RSS) Session	103
Initiating an RSS Session	104
Pausing and Resuming an RSS Session	105
Ending the RSS Session	106
Appendix A: Specifications	107
GRV-R7-MM1001-10	107
Features	108
Specifications	109
Wiring Assignments	113
Appendix B: Wiring Diagrams	115
Wiring Field Devices	115
<i>groov</i> RIO Explorer	115
GRV-R7-MM1001-10	116
Appendix C: <i>groov</i> RIO Explorer	117
The <i>groov</i> RIO Explorer	118
Assigning Functions and Signals to a Channel	119
Moving and Deleting Signals	120
Viewing Possible Signals and Channels	120
Replacing a Signal	121
Exporting and Importing Combinations of Functions and Signals	122
Exporting	122
Importing	122
Working with Samples	123

1: Welcome

WELCOME TO *groov* RIO!

Opto 22's *groov* RIO® is an independent, intelligent Ethernet-based input/output (I/O) unit designed as edge I/O for industrial internet of things (IIoT) applications. *groov* RIO solves two main problems with most remote I/O today:

- First, instead of requiring you to specify several components (rack, power supply, bus coupler, module types, and more), which is time-consuming, difficult, and requires significant domain expertise, **one part number is all you need**. One part number includes built-in multifunction, multi-signal I/O; an I/O processor; power over Ethernet (PoE); and mounting without the need for a rack or chassis—all in a compact industrial package.
- Second, communicating data among field devices, control systems, company software, and cloud services is no longer complex and costly, requiring PLCs, programming, and middleware. Instead, ***groov* RIO simplifies IIoT and automation applications** by including built-in processing and communications: web-based configuration, flow logic software, efficient data communication methods, and multiple automation and information technology protocols.

With *groov* RIO, you don't need a PLC, PAC, or industrial PC. You can place the unit almost anywhere, configure it using just a web browser, and communicate data between field devices and on-premises or cloud-based systems and software.



***groov* RIO offers features for a variety of applications. You can:**

- Place the unit almost anywhere. *groov* RIO operates through a wide range of operating temperatures (-20 to 70 °C), and is UL Hazardous Locations approved and ATEX compliant. Mount it on a DIN rail or panel.
- Supply power to *groov* RIO and field I/O through the ETH1 network interface using PoE connections, or provide 10-32VDC power.
- Simplify field connections using the 26-pin removable field connector with spring clamp wire retention. Supports wire sizes 16 to 12 AWG.
- Use web-based software to configure I/O channels: inputs or outputs; signals including voltage, current, thermocouple, ICTD; mechanical relays. Over 62,000 field I/O combinations are possible in one unit.
- Use intelligent features like counting, latching, clamping, and more.
- Connect additional devices like a Wi-Fi adapter, a USB memory stick (up to 32 GB), or a USB-to-serial adapter via the *groov* RIO's USB host port (you supply the additional devices).
- Easily see the status of power, network, and I/O activity on the unit's LEDs.
- Use embedded software to quickly set up data communications.

groov RIO as Edge I/O

groov RIO is primarily used as edge I/O in IIoT applications. As you can see in the diagram below, edge I/O bridges the operations technology (OT) world of sensors and actuators, shown at the bottom of the diagram, and the information technology (IT) world of computers and corporate software, at the top.

groov RIO's embedded software and protocol support make it possible to exchange data between these two realms more easily and securely. Embedded software and protocol support include:

- **groov Manage**—Web-based software for configuring groov RIO I/O channels, security, and communications
- **Node-RED**—Software for creating simple data flows to send data to cloud services, databases, other I/O channels, and APIs. Pre-built nodes make flow creation easy.
- **MQTT**—Built-in support for MQTT, an efficient publish/subscribe protocol for exchanging data. Only a simple configuration is needed to publish I/O data and subscribe to commands as Sparkplug-B or string payloads.
- **Modbus®/TCP**—Support for the well-known industrial protocol. groov RIO acts as a Modbus/TCP slave right out of the box.

groov RIO as Edge I/O

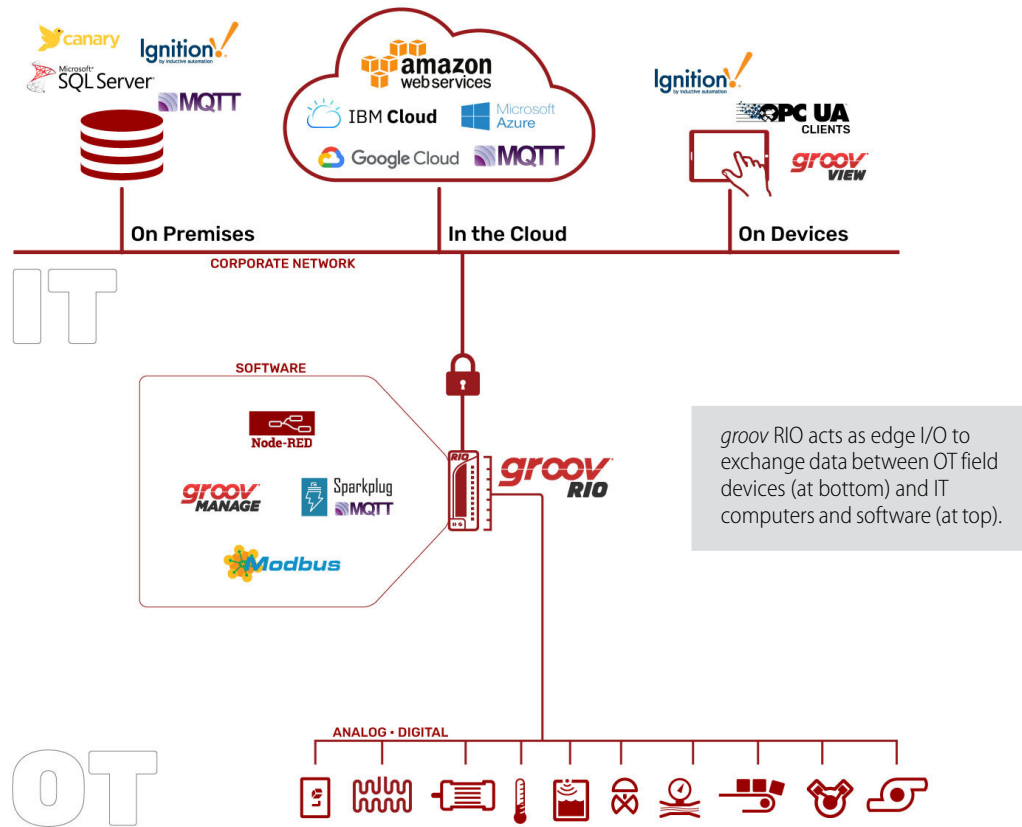

groov RIO as Remote I/O in an Opto 22 Control System

In addition to its use as independent edge I/O for IIoT applications, *groov* RIO can also be used as remote I/O with an Opto 22 *groov* EPIC® processor or SNAP PAC controller. The diagram below shows RIO used with *groov* EPIC.

groov RIO is wired to field devices and acts as an I/O unit within the EPIC's control and I/O network. As an I/O unit, *groov* RIO is compatible with any of the EPIC's programming methods—PAC Control, CODESYS and IEC 61131-3 languages like Ladder Diagram and Function Block Diagram, or languages like C/C++ or Python to build custom control programs. If you have a custom control program, you can access *groov* RIO using its OptoMMP memory map addresses or via REST APIs.

groov RIO as Remote I/O in an Opto 22 Control System

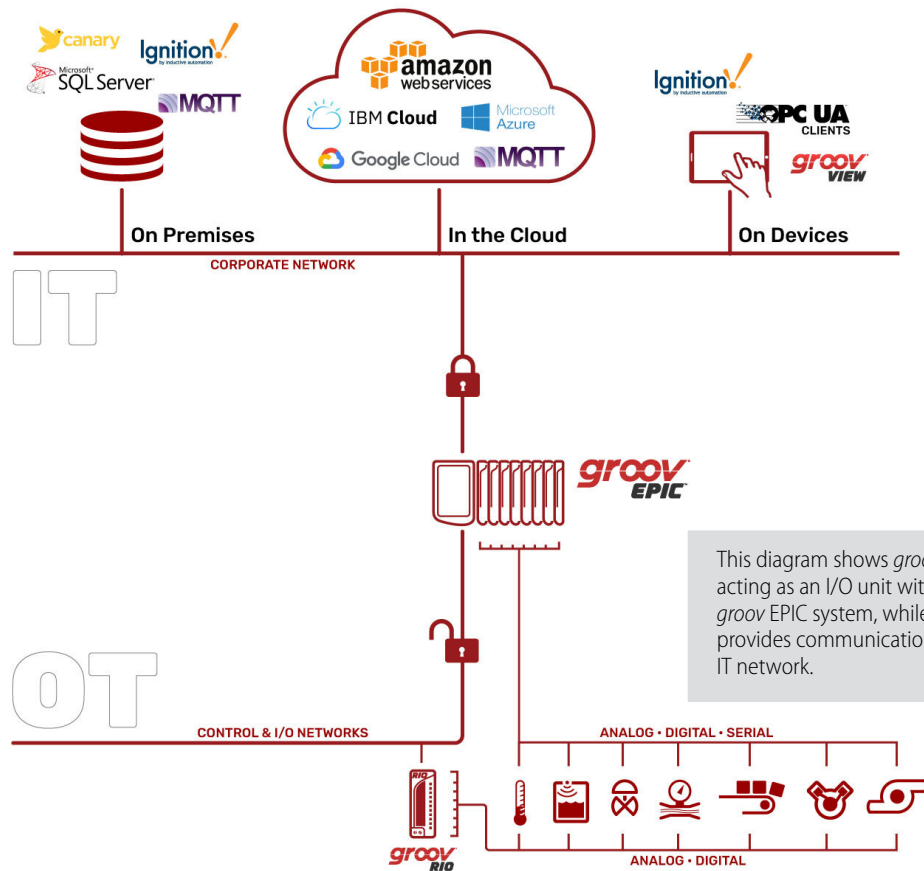

groov RIO with Modbus/TCP or Custom PC-based Control Programs

groov RIO can also be accessed by Modbus/TCP masters and by PCs running custom-built control programs:

Modbus/TCP—Because groov RIO is a Modbus/TCP slave out of the box, you can use your favorite Modbus/TCP master device or software to poll RIO's I/O channels.

C++ or .NET and free SDKs—With your favorite development tool and our free SDKs, you can programmatically access I/O values on a groov RIO unit by accessing the OptoMMP memory map locations of each channel.

HTTP/S, JSON, and REST APIs—Opto 22 provides REST APIs for groov Manage, which you use to access the I/O values on a RIO unit. A Swagger API document is built into RIO to quickly access REST API calls and evaluate responses.

groov RIO with Modbus/TCP or Custom PC-based Control Programs

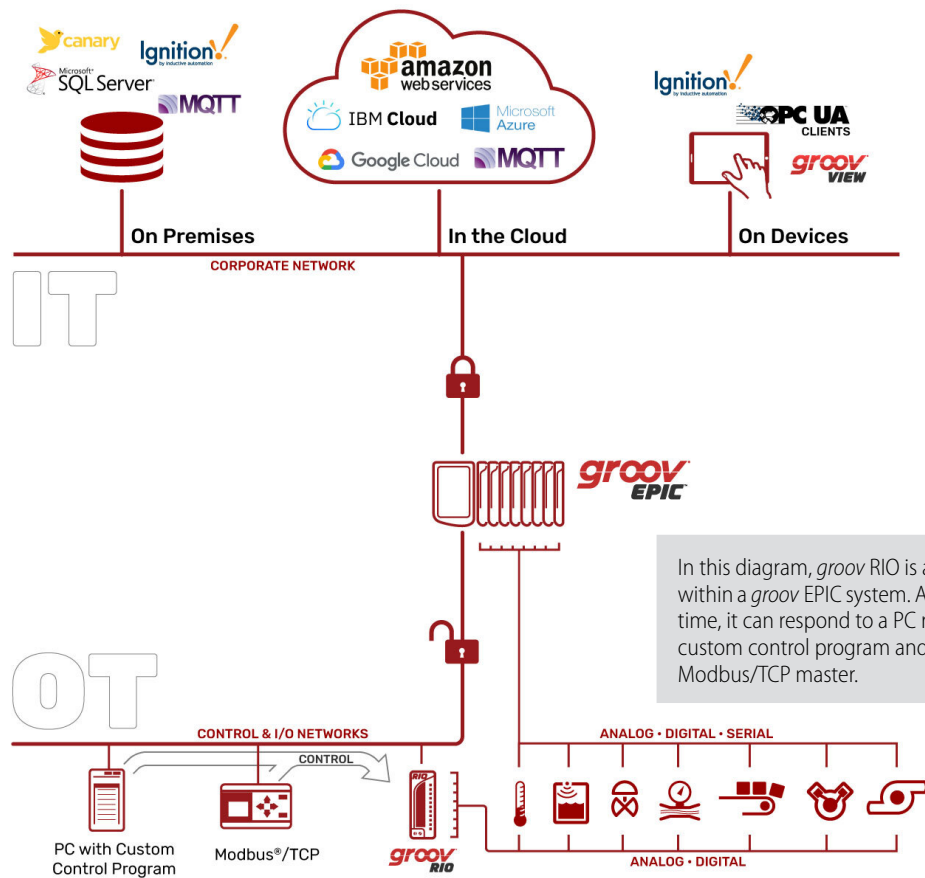

REQUIREMENTS

Power Requirements

There are two ways to provide power to a *groov* RIO:

- An external 10 to 32 V DC power source or supply capable of providing at least 10 Watts
- Power over Ethernet (PoE) through the ETH1 port (star topology only)

Field Device Wiring

Connect field devices to *groov* RIO with wire of size 28-14 AWG. Keep the wires as short as possible.

Software Requirements

If you are using *groov* RIO as an independent edge I/O unit, all you need is a web browser to configure I/O, security, and networking, and to create Node-RED flows.

If you are using *groov* RIO as remote I/O with an Opto 22 system running:

- a PAC Control strategy, you need to run PAC Project 10.3000 or higher. If you are running a PAC Control strategy on a:
 - *groov* EPIC processor, you need GRV-EPIC-PR1 firmware version 2.0.0 or higher.
 - SNAP PAC controller, you need firmware 10.3a or higher.
- a CODESYS application, you need CODESYS Development System, V3.5 SP15 Patch 1 or newer (32-bit version) with Opto 22 Library Package for CODESYS Development System version 2.0.0.0 installed.

ABOUT THIS GUIDE

This user's guide shows you how to mount your *groov* RIO, how to connect field devices, how to configure the I/O channels, and much more.

What's In This Guide?

Chapter 1: Welcome describes *groov* RIO and how this document is organized.

Chapter 2: Mounting and Connecting a *groov* RIO describes all the requirements for supplying power, plus instructions on mounting and wiring a *groov* RIO.

Chapter 3: Initializing a *groov* RIO describes what to do after you power up your *groov* RIO, which includes creating the first user ID, which has administrator privileges.

Chapter 4: Navigating *groov* Manage describes how to navigate through *groov* Manage and find some important information.

Chapter 5: Start to Finish—Transmit, Log, and Visualize describes how you could get data that your RIO is collecting into a simple HMI, logged into a file, or transmitted (published) to an MQTT broker (and, therefore, MQTT clients that subscribe to your RIO's data) without writing a single line of code.

Chapter 5: Controlling Access to *groov* RIO describes how you configure RIO to limit what services can connect to it.

Chapter 6: Connecting *groov* RIO to a Network or Multiple Networks describes all the factors to consider when you connect a RIO to a network, from a single, simple network to a complex set of networks.

SERVICE AND MAINTENANCE

Chapter 7: Configuring a groov RIO describes what to do after you finish initializing *groov* RIO, which includes setting date, time, and time zones; attaching USB devices, and enabling Node-RED.

Chapter 8: Configuring I/O describes how to select the functions (input or output), signal types (discrete, analog), and any corresponding features for each channel through *groov* Manage. It also describes where to find information if you want to write a PAC Control strategy or custom application can access your RIO.

Chapter 9: Enabling MQTT introduces you to MQTT, how it works in RIO, and how to configure it.

Chapter 10: Developing Node-RED Flows describes what an experienced Node-RED developer needs to know to start writing flows that access RIO's data, as well as provide step-by-step instructions for those new to Node-RED.

Chapter 11: Maintaining a groov RIO describes all the tasks you can do to keep your RIO performing smoothly, how to install firmware updates, perform periodic backups, review guidance to do basic troubleshooting, information to collect should you need to contact Product Support, and an overview of how to conduct an OptoRSS (Remote Support Service) session.

Appendix A: Specifications lists the specifications for each channel of a RIO, as well as the specifications common to all channels on a RIO.

Appendix B: Wiring Diagrams lists all the wiring diagrams for a GRV-R7-MM1001-10.

Appendix C: groov RIO Explorer describes our online app that helps you see different combinations and arrangements of channel configurations, help you choose combinations and arrangements that are valid, and create wiring diagrams for your chosen combination.

SERVICE AND MAINTENANCE

To keep your *groov* RIO up-to-date with the latest firmware fixes and features, you'll want to regularly check for and apply maintenance, as described in ["Updating Firmware on a groov RIO" on page 96](#).

If you encounter any problems with your *groov* RIO, follow the instructions in ["Collecting Information for Product Support" on page 103](#) before contacting Opto 22 Product Support.

Service (Product Support)

If you are having problems installing or using *groov* RIO products and cannot find the help you need in this guide or on our website, contact Opto 22 Product Support.

Phone: 800-TEK-OPTO (800-835-6786 toll-free in the U.S. and Canada)
951-695-3080
Monday through Friday,
7 a.m. to 5 p.m. Pacific Time

Fax: 951-695-3017

Email: support@opto22.com

Opto 22 website: www.opto22.com

NOTE: Email messages and phone calls to Opto 22 Product Support are grouped together and answered in the order received.

2: Mounting and Connecting a *groov* RIO

GATHERING YOUR EQUIPMENT AND INFORMATION

Gathering up all the supplies, information, and equipment you need before you mount, connect, and initialize your *groov* RIO can help get your unit up and running more quickly:

- An accessible power source that complies with the requirements described in [“Power Requirements” on page 5](#).
- The proper gauge wires to connect the *groov* RIO to your field devices as described in [“Field Device Wiring” on page 5](#).
- Pen and paper to note important information that you might need during this process or to keep for future reference.
- The spring clamp tool that ships with your *groov* RIO, which helps you connect field device wires to the correct pins on the terminal connector.

In addition, make sure you have a list of all the I/O channels (sometimes referred to as points) that you need set up. This might be in a form of a document that maps which channels will connect to a specific field device/point. If you are working with a terminal strip, review the terminal number assignments, making sure you understand which terminal numbers are assigned to specific channels.

If you are connecting multiple *groov* RIOs, you'll need to determine if you are connecting them in a daisy-chain formation or star formation.

After you assemble your unit, you'll initialize it as described in [“3: Initializing a *groov* RIO” on page 15](#). After you finish initializing the unit, it will be ready to run.

Familiarizing Yourself with *groov* RIO

Take a look at the *groov* RIO unit now and familiarize yourself with its features, shown in the diagrams on the following page. You can always come back and review these diagrams when you need to.

groov RIO: Front View

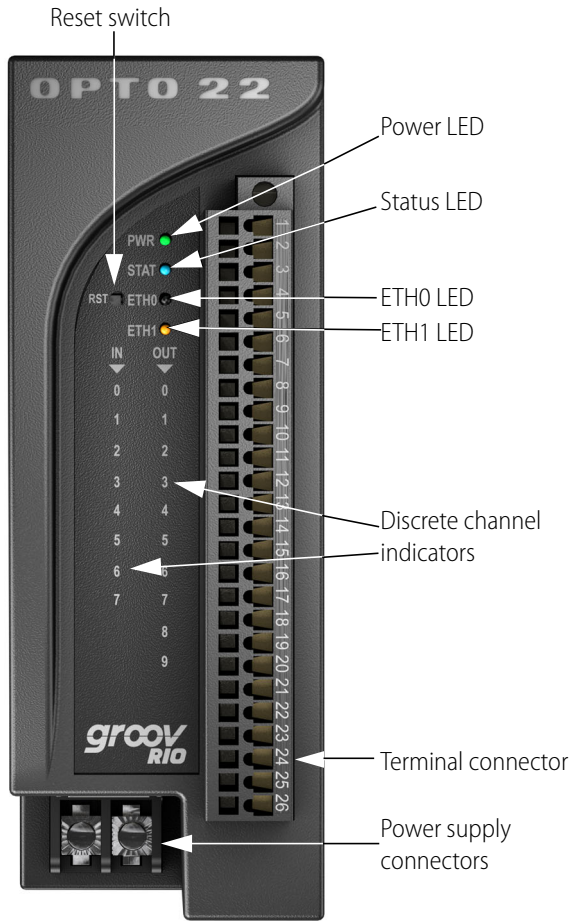

LEDs

LED	Indicates
POWER	The status of power.
	<ul style="list-style-type: none"> • Solid green—RIO is powered on. • Solid red—RIO is restarting.
STATUS	Whether RIO is running or resetting.
	<ul style="list-style-type: none"> • Solid green—RIO is running normally. • Blinking green—RIO is starting (power on) or restarting (initiated by Reset Switch). • Blinking between green and red—RIO is resetting to factory defaults.
	Network connection speed and whether there is any transmission activity:
ETH0, ETH1	<ul style="list-style-type: none"> • Solid green: 1 Gbps; transmission activity = No • Blinking green: 1 Gbps; transmission activity = Yes • Solid orange: 10 or 100 Mbps; transmission activity = No • Blinking orange: 10 or 100 Mbps; transmission activity = Yes

groov RIO: Bottom View

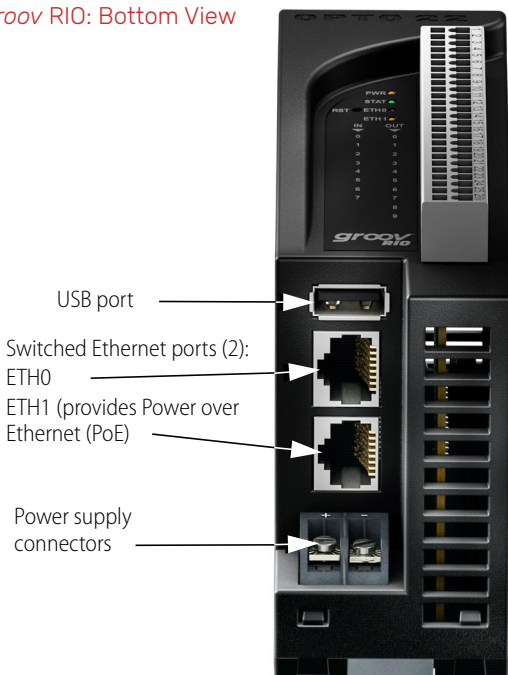

groov RIO: Back View

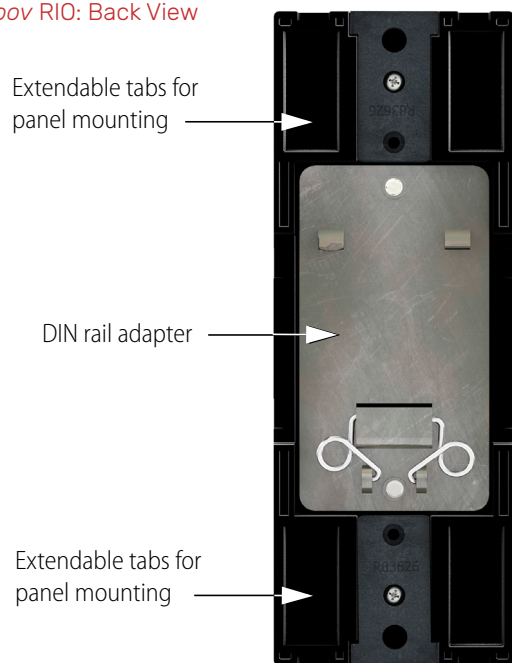

MOUNTING

You can mount *groov* RIOs onto DIN rail or onto a panel.

Before mounting, make sure that there is a minimum of 2 inches clearance on the top, and 1 inch clearance on the bottom, on each side, and in front of RIO after it is mounted. Mount RIO as shown in the diagram: with the Opto 22 logo at the top. Compliance with these guidelines will help ensure that the *groov* RIO performs as described in the specifications.

Mounting on DIN Rail

Before mounting your RIO:

- Ensure that the vents around RIO are not obstructed.
- Ensure that the mounting location meets the clearances described above.

The *groov* RIO is built with DIN rail adapters for use on 35 mm DIN rail. No additional assembly is required.

To mount RIO to a DIN rail, follow these steps:

1. Hold RIO so that the Opto 22 logo is at the top and at an angle such that the top of the DIN rail adapter is away from the DIN rail and the bottom of the DIN rail adapter can slide behind the bottom lip of the DIN rail. See the circled area in the image below.

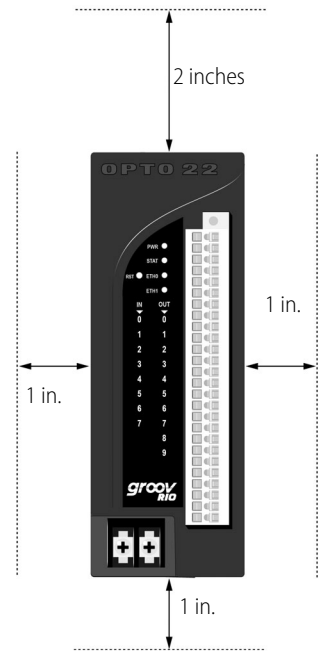
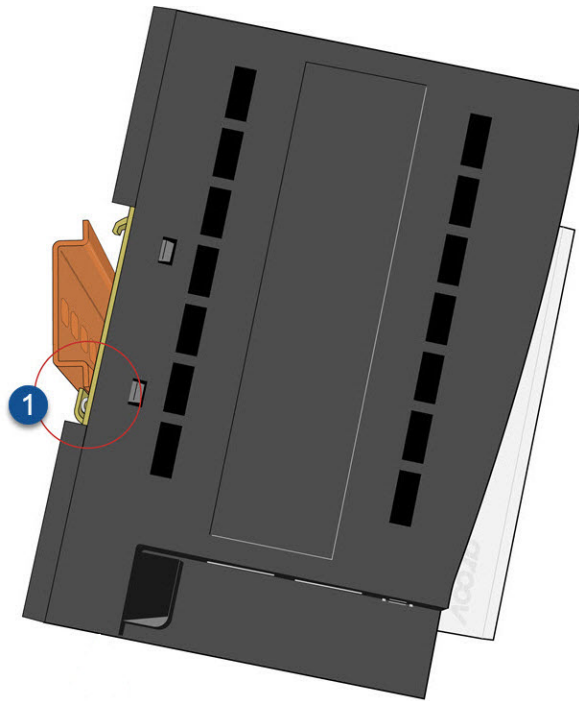

2. Push the bottom part of RIO upward, making sure that you feel the clip catch on to the rail, and simultaneously push the top half of RIO toward the DIN rail until the top of the DIN rail adapter engages the top lip of the DIN rail.

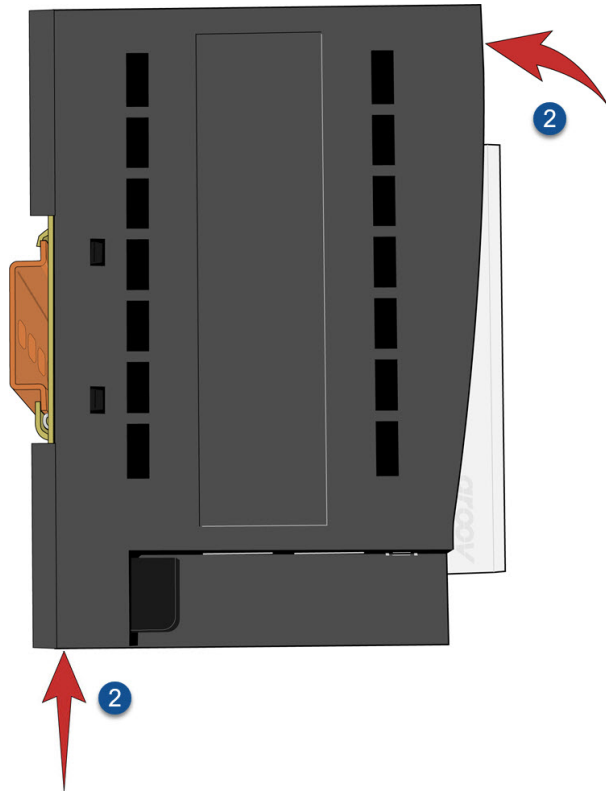

Before you release RIO, verify that the top and bottom of the DIN rail adapters have engaged the DIN rail.

Mounting on a Panel

Before mounting your RIO:

- Ensure that the vents around RIO are not obstructed.
- Review the clearances requirements described in the previous page.

1. First, extend the mounting tabs:
 - a. Turn the RIO so you can see the backside.
 - b. With a small Phillips screw driver, remove the screw on one tabs.
 - c. Slide the tabs out so the middle hole on the tab aligns with the screw hole on the RIO.
 - d. Reinsert the screw to the torque indicated in the "Common Characteristics" section of the specifications (see "Specifications" on page 109).
 - e. Repeat steps b through d with the other tab.

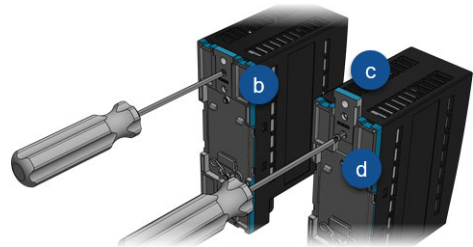

2. To mark holes on the panel and verify placement before attaching the RIO, use the RIO as a template.
3. Attach the RIO to the panel with screws (not provided).

CONNECTING FIELD DEVICES

Because you can configure each channel to be an input or an output, as well as different signal types, it is very important that you determine how each channel will be configured before you start wiring field devices to the pins. For important information and guidance on selecting channel configurations, see [“Selecting Functions, Signals, and Features”](#) on page 59.

Wiring Field Devices to *groov* RIO

Before you begin wiring, do the following tasks:

CAUTION: For electrical safety, turn off power to the *groov* RIO and de-energize field devices wired to the terminal connector before starting.

- Select the appropriate wire. The terminal connectors are rated for 28–14 AWG wire. If you’re using stranded wire, you can make an easier and better connection by tinning the strands or adding ferrules.
- Ensure that you have the spring clamp tool supplied with your *groov* RIO.
- If you are unfamiliar with the names of some of the parts of the *groov* RIO, review the diagrams on [page 11](#).
- It may be easier to insert wires if you remove the terminal connector from the RIO. To remove the terminal connector, loosen the terminal connector screw at one end of the connector, then pull the connector straight out to remove it from the *groov* RIO.
- If you have never used a spring-clamp wiring system, take a moment to familiarize yourself with the diagram below. The clamp release hole is where you will insert the spring clamp tool. The field wiring hole is where you will insert your field wires.

If you look into the field wiring hole, you will see a highly reflective surface. If you can see that surface, that means that the clamp is closed.

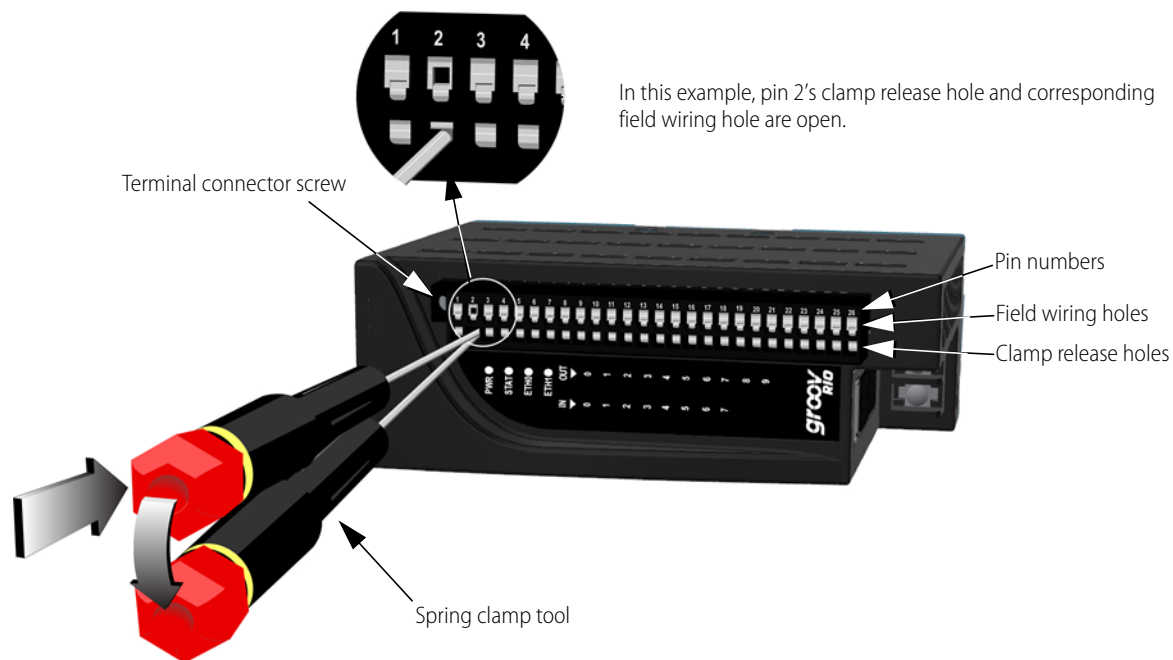

Follow these instructions to connect your field wires to the terminal connector:

CONNECTING POWER SUPPLY

CAUTION: For electrical safety, turn off power to the groov RIO and de-energize field devices wired to the terminal connector before starting.

1. Orient the *groov* RIO or terminal connector to match the wiring diagrams. To make it easier to handle the spring clamp tool and the field wires, secure the *groov* RIO or terminal connector by doing one of the following:
 - If you are working with the terminal connector while it is attached to the *groov* RIO, make sure the *groov* RIO is attached securely to the panel.
 - If you are working only with the terminal connector, secure the terminal connector with a clamp.
2. Slide the spring clamp tool into the clamp release hole, along the left side, until you feel the end begin to meet some resistance. Gently push the tool in a little more, until you feel it stop.
 - Look into the field wiring hole. If it is dark, the clamp is open. You can go to the next step.
 - If you can still see the highly reflective surface, gently pull the tool's handle to the left until you feel it stop. Hold the tool in that position. Look into the field wiring hole. If it is dark, the clamp is open. You can go to the next step.
3. Insert the wire into the field wiring hole until it meets complete resistance. Then pull out the spring clamp tool.
4. Test that the wire is secure by gently pulling on it. If the wire pulls out, repeat steps 2 through 3.

To remove a wire, push the spring clamp tool into the clamp release hole as described in [step 2](#) above, and then pull the wire out.

CONNECTING POWER SUPPLY

As mentioned in “Power Requirements” on page 5, there are two ways to provide power to a *groov* RIO.

- An external 10 to 32 V DC power source or supply capable of providing at least 10 Watts
- Power over Ethernet (PoE, 802.3af Class 0) through the ETH1 network interface (star topology only)

External Power Source or Supply

If you choose to supply power with an external power supply, Opto 22 recommends you connect the supply with wire size 22-14 AWG. Keep the wires as short as possible.



After you connect the external power source or supply, connect the Ethernet cable, and proceed to [Chapter 3: Initializing a groov RIO](#).

Power Over Ethernet

If you choose to supply power with an Ethernet cable through the ETH1 network interface, Opto 22 recommends you use a Power Sourcing Equipment (PSE) that supports IEEE 802.3af and has sufficient power available for all the powered devices (PDs) connected to it.

The *groov* RIO begins to power up as soon as the Ethernet cable connects ETH1 on the RIO to a PoE PSE device (for example, a PoE compatible Ethernet Switch or injector). Then you can proceed to [Chapter 3: Initializing a groov RIO](#).

3: Initializing a *groov* RIO

After you connect your *groov* RIO to a power supply and a network, it runs through its start-up sequence, which includes obtaining an IP address from the DNS server on the network.

- If your network uses DNS and DHCP to assign and manage IP addresses, you can start with [step 1](#) (below).
- If your network does not use DNS and DHCP to assign and manage IP addresses, you will need to install and run (on a Windows machine) *groov* Find. (Make note of the IP address that *groov* Find identifies for your *groov* RIO for future reference.) Then you can go to [step 3](#) (below) and use the IP address instead of the host name. If you are not familiar with *groov* Find, see “[Downloading and Running groov Find](#)” on [page 100](#).

Your first tasks will be to log into *groov* Manage, create the first administrator account, determine if you need to run Quick Start, and check whether you have the latest firmware installed.

1. Wait for the STAT LED to stop blinking and show a solid green color.
2. From a computer or mobile device connected to the same network, open up a web browser.
3. In the URL bar, enter `https://<RIO default hostname>`, where `<RIO default hostname>` is the host name listed on the label on the side of unit.



The Welcome! screen appears on the browser window.

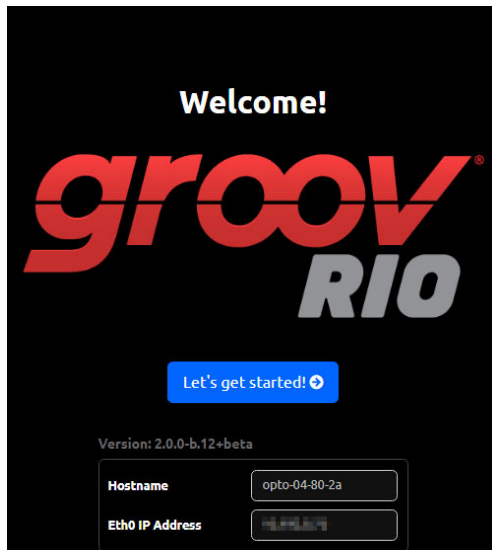

If, after a few minutes, you do not see the Welcome! screen or you can get an error from the browser, check [“Browser Reports that URL to RIO is Unreachable”](#) on page 99.

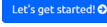
4. Click Let's get started! (). You'll see the Create an Account screen.

Read the information in the warning box. This first administrator account is very important because it provides administrator privileges over the *groov* RIO, which gives you access to all the functions you need to configure it, maintain it, and create other accounts. It's also important to remember the username and password to this account. The *groov* RIO does not provide a way to recover this password nor an alternate way to access this account if you forget the password. Also, Opto 22 cannot recover this password or provide access to the account.

5. Type in a user ID and password for this administrator account, then click Create Account.

It is a good idea to follow best practices regarding passwords (for example, mixing cases and including numbers) when you create your password. Your password must be a minimum of 1 character and can be a maximum of 128 characters.

6. *groov* Manage displays a screen with these options:

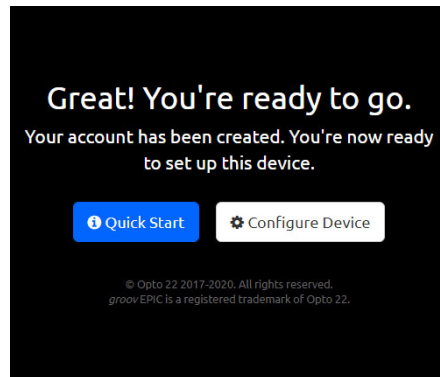

- **Quick Start**—The quick start provides a list of suggested configuration steps that you should complete first to get your *groov* RIO up and running. You may want to choose this option if this is the first time you configure a *groov* RIO. If you select this option, go to the next step.
 - **Configure Device**—If you select this option, *groov* Manage displays the Home page, where you can make any configuration changes. You may want to choose this option if you have configured a *groov* RIO before or you feel confident you have all the information and understand the technology and software installed on the RIO to complete any configuration steps. If you select this option, skip to [step 8](#).
7. Click Quick Start. *groov* Manage displays the Quick Start page.

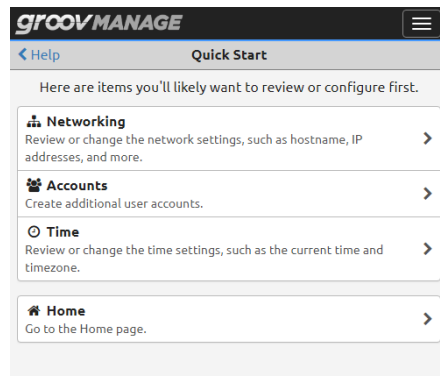

The boxes are organized to suggest an order in which to complete the configuration. However, you do not have to follow this order nor do a configuration task for every box. Here's why you might want to complete each step:

- **Networking**—You might want to configure or change networking settings because you want to change the IP address or hostname that was assigned to the unit. You might want to set the IP address manually (which would make it a static IP address) or disable a network interface.
- **Accounts**—You might want to create additional accounts as required by the design of your site.
- **Time**—You can choose between manually setting the date and time, selecting a time zone from a list, or selecting a time server that will synchronize your unit's date and time with that time server's date and time.

After you finish each configuration task, click back to return to the Quick Start page.

8. In *groov* Manage, click the menu button () , then select Info and Help.
9. In the Info and Help page, click About.
10. In the *groov* RIO section, note the version in the System Version field.

11. Log on to opto22.com and enter the part number for your *groov* RIO in the Search box. Select the search result that includes “Firmware” as part of the title; for example GRV-R7-MM1001-10 Firmware.
12. Note the firmware version number listed on the page.
 - If the version number on the web page is the same as the version number you noted in [step 10](#), you have the latest version of firmware installed on your *groov* RIO. You can continue on to selecting the functions, signal types, and features for each channel and configuring *groov* RIO.
 - If the version number on the web page is larger than the version number you noted in [step 10](#), you need to update the firmware on your *groov* RIO. Follow the instructions in [“Updating Firmware on a *groov* RIO” on page 96](#). After you update the firmware, you can continue on to selecting the functions, signal types, and features for each channel and configuring *groov* RIO.

4: Navigating *groov* Manage

When you connect to *groov* RIO through a web browser on a computer, you navigate through the web browser in much the same way you navigate through any other web application on your computer. You can click on navigation aides like the navigation bar or links, and scroll up and down with a mouse.

UNDERSTANDING THE PAGE NAVIGATION AIDS

The diagram below identifies some of the important page navigation aids:

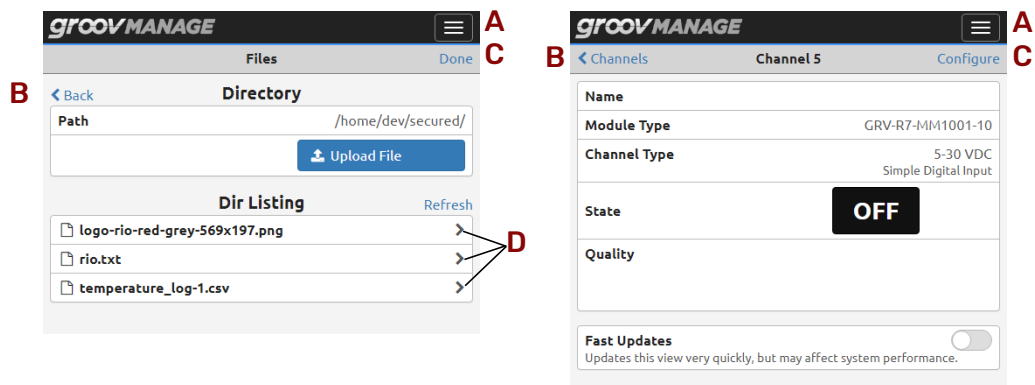

- A** Menu button (☰). Click or tap on this button to access a list of important pages. This button can help you quickly jump to these pages.
- B** Cancel or previous page. The upper-left area of the page provides a way to cancel any changes you might have made to fields on the current page, return to the previous page, or both.
- C** Save, Configure, or Done. If there are settings on the page that you can change, the upper-right area of the page displays the word Configure. Click on Configure to open up the page where you actually make the changes.
If this area shows the word Save, you must click on it to save any changes you made to settings on the page. If, after saving, the processor must restart an application or service, it displays a message to let you know.
If this area is blank, that means you can't make any changes to this page.
- D** Links. When you see these arrows, it indicates that clicking or tapping on the arrow will open another page that displays more information and provides more functions related to the item. For example, when you click Project Management in the Node-RED page, *groov* Manage displays another page with information and functions to help you manage a Node-RED project.

LEARNING HOW INFORMATION IS ORGANIZED IN *groov* MANAGE

At the top of the *groov* Manage page is a navigation bar that always remains visible as you navigate through the screens. This navigation bar contains a menu button (☰) that gives you quick access to the most frequently visited screens of *groov* Manage:

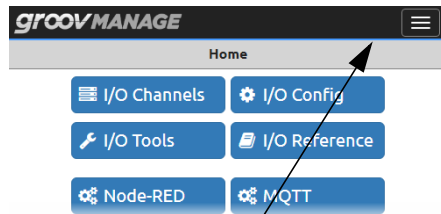

Navigation bar, with the menu button closed.

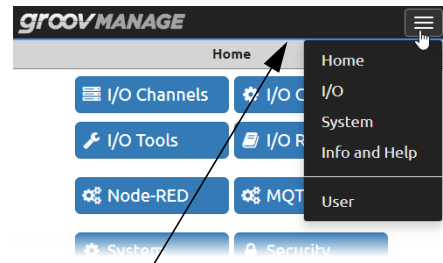

Navigation bar, with the menu button open.

- **Home**, the main page of *groov* Manage.
- **I/O**, the page that displays a visual representation of channels on the RIO unit.
- **System**, the page that displays functions to help you configure system-level settings, like network settings, time zone settings, file manage, and the ability to restart RIO.
- **Info and Help**, the page that gives you access to more information about RIO, like RIO unit log files, RIO unit information, on-board documentation, firmware versions, as well as a way to access the Quick Start page.
- **User**, the page that displays the user name of the current user and the fields to change the current user's password.

Navigating Through *groov* Manage on a Computer or Mobile Device

You can navigate through *groov* Manage on a computer or mobile device in much the same way you navigate through any other web application. You can **Drag-and-drop**—a feature commonly used on a computer to visually and easily move files from one location to another. You can drag-and-drop files into *groov* RIO on any *groov* Manage page with an upload button.

FINDING INFORMATION ABOUT I/O CHANNELS

To view information about and making changes to channels, you access I/O Channels page of *groov* Manage. To reach that page, log into your *groov* RIO with a user ID that has administrator privileges and then do any of the following:

- Click or tap on the menu button (☰), then select I/O.
- In the Home page, click or tap on I/O Channels.

Either action displays the I/O Channels page. The page displays a table where each row is a channel.

The screenshot shows the 'groovMANAGE' application interface. At the top, there is a navigation bar with a 'Home' button and a hamburger menu icon. Below this is a header for the 'I/O Channels' page. The main content is a table with six rows, each representing a channel. Callout 'A' points to the first two columns of the first row, and callout 'B' points to the last two columns of the first row.

Channel Number	Function	Signal Type	Channel Name	Signal Summary
0	DI	DI	Input_Zero	OFF
1	DO	DO	Input_One	ON
2	AI	AI	Temp_One	66.870 Degrees F
3	AI	AI	Temp_Two	67.495 Degrees F
4	DI	DI	< no name >	OFF
5	DI	DI	< no name >	OFF

- A** The grey box shows the channel number at the top, the function and signal type on the bottom.
- B** For each channel, this area shows the channel name (if one has been assigned) at the top and a summary of the signal information on the bottom. The summary varies; it could be the state of a discrete input or output, the temperature reading from an ICTD probe, or quality indication.

5: Controlling Access to *groov* RIO

PART OF AN OVERALL SECURITY SYSTEM

When you control access to *groov* RIO, consider it as part of a total security system that includes other best practices you might want to implement; for example, requiring that authorized users change their passwords every three months or securing the control equipment in a locked cabinet with keys accessible to a limited number of personnel.

IMPORTANT: *groov* Manage does not provide timeout-based logout. You must implement the important practice of always logging out of any ID that has administrator privileges to prevent unauthorized access to RIO.

CREATING USER IDS AND CONFIGURING THEIR ACCESS

With *groov* Manage, you can create user IDs and limit access to RIO functionality and features. Before you create a user ID, consider the following questions:

- How many users do you want to create?
- What functions do you want the users to access?
- How will you secure (encrypt or password-protect) the information about the users?

Choosing Access Levels for Users

The following information can help you determine what access to give a user and what level of access to give a user for a particular service or feature:

- A unit-wide administrator can do the following:
 - Create other user accounts
 - Access all services running on this unit
 - Change the passwords of other accounts
 - Sign out any and all users currently logged into this unit
 - Change unit-wide settings like network, I/O, time and date, etc.
- *groov* Manage—*groov* Manage is an administrator-level function, so if the user is a unit-wide administrator, they have access to *groov* Manage. If the user is not a unit-wide administrator, they do not have access to *groov* Manage.
- Node-RED—Access to Node-RED is either Editor or Off. For unit-wide administrators, Editor is the automatic and only access level. For all other users, you can set the access level to either Editor or Off.
- PAC REST API—Access to the PAC REST APIs can be one of the following:
 - Read-Write
 - Read-Only
 - None

Creating User IDs

After you consider what types of users you want to create and what they will have access to, do the following:

1. Log into your *groov* RIO with a user ID that has administrator privileges.
2. Click Accounts.
3. Click Add (in the upper right corner).
4. Type in the required information and select the permissions you want that user to have.
5. Click Save (in the upper right corner).

Repeat these steps for every user account you want to create.

MANAGING THE SSL SECURITY FEATURES OF YOUR *groov* RIO

The SSL security features on *groov* RIO help you establish secure communication between RIO and web browsers, servers, brokers, and cloud services.

Learning How SSL Works on *groov* RIO

If you are not familiar with SSL, you might want to spend some time reading the following OptoBlog, [Understanding SSL/TLS and HTTPS](#).

Each *groov* RIO comes with a unique certificate (called a self-signed, server SSL certificate) to enable communication between its internal web applications (like *groov* Manage and Node-RED) and web browsers on computers and mobile devices. When you connect to *groov* RIO through a web browser for the first time, the browser displays a warning message that the site (in this case, *your groov* RIO) is untrusted. To avoid the warning, you can install the self-signed, server SSL certificate into the certificate store of the web browser. Afterwards, the browser will “trust” your RIO (the site) and no longer display that warning.

Creating a Self-Signed Certificate

1. Log into your *groov* RIO with a user ID that has administrator privileges.
2. Click Security > Server SSL > Create Certificate.
3. In the Create Certificate page, enter the information requested.

Server Name—Enter the fully qualified domain name or IP address of this *groov* RIO that others will use to access it. The server name may contain letters a–z (case insensitive), digits 0–9, or a hyphen (-). No other characters are allowed. The server name must not start with a hyphen.

Example:

If the URL that others will use to access the RIO is `https://process1.acme.com`, then type in `process1.acme.com`

Example:

If the URL that others will use to access the RIO is `https://mobilehmi.mydomain.com`, then type in `mobilehmi.mydomain.com`

Email—The email address of the individual in your organization requesting the certificate and who would be responsible for responding to any inquiries about this certificate.

Department—Information to differentiate between divisions within an organization. For example, “Engineering” or “IT”. If applicable, you can enter the DBA (doing business as) name in this field.

Organization—The legally registered name of your business. The listed organization must be the legal registrant of the domain name in the certificate request. If you are enrolling as a small business or sole proprietor, please enter the certificate requester’s name in this field, and the DBA (doing business as) name in the Organizational Unit field.

City or Locality—Name of the city or locality where your organization is located. Please spell out the name of the city or locality. Do not abbreviate.

State—Name of state, province, region, territory where your organization is located. Please enter the full name. Do not abbreviate.

Country Code—The two-letter International Organization for Standardization (ISO-) format country code for the country in which your organization is legally registered. See <http://www.digicert.com/ssl-certificate-country-codes.htm> for a list of codes. For example, the code for the United States is US.

Days until expiration—Enter the number of days before the certificate is expired and has to be replaced. Opto 22 recommends 3560 (10 years).

RSA key size—Enter the size of the RSA key. The default size of 2048 is a generally recommended value. Higher values will take longer to create.

4. Click Create. *groov* Manage immediately installs the new private key and certificate, and then restarts *groov* Manage.

Your *groov* RIO now has new copies of the Public Certificate, Private key, and CSR, which you can download when you need to request a CA-signed certificate.

Switching to a CA-signed Certificate

When you switch to a CA-signed certificate, consider the following:

- The cost of a certificate from a certificate authority ranges from free to \$300 or more, depending on the features and company you buy them from. Please work with your IT department before you begin this task.
- You will send the CSR to the certificate authority of your choice. The certificate authority verifies the identification information and signs the CSR, which then becomes a CA-signed certificate. That's why it is important that you enter accurate information in [step 3 of "Creating a Self-Signed Certificate" on page 24](#).

If you have not created a self-signed certificate, do that first. See ["Creating a Self-Signed Certificate" on page 24](#).

1. Log into your *groov* RIO with a user ID that has administrator privileges.
2. Click Security > Server SSL > Download CSR.
3. Navigate to a folder where you want to store the CSR file. Make a note of the file name and path to the folder. Click Save.
4. Go to the certificate authority (most likely a web site) and provide them with the information they request in whatever format they request.

When filling out a form for a CA-signed certificate, keep in mind that an SSL certificate works with any operating system. If you are asked to select an operating system, select "other" if it an option. It's OK to select a specific operating system, if necessary.

5. Finish the transaction with the certificate authority and receive your new SSL certificate.
6. Upload the new SSL certificate to your *groov* RIO:
 - a. Return to the View Certificate page. (See steps 1 and 2.)
 - b. Click Upload Certificate.
 - c. Click Public Certificate.
 - d. Navigate to the folder where you stored the new SSL certificate. Click Open. *groov* Manage uploads the file and then displays the Upload Certificate page.
 - e. Click Private Key.
 - f. Navigate to the folder where you stored the private key file. Click Open. *groov* Manage uploads the file and then displays the Upload Certificate page.
 - g. Click Upload (in the top right). *groov* Manage displays a message that it must restart. Click on Reload.

After *groov* Manage restarts, you can begin working with services that requires a CA-signed certificate.

Uploading a Public Key Certificate

There are several reasons you might need to upload a public key certificate:

- To enable secure client/server communication (with HTTPS or TLS/SSL) between your *groov* RIO (acting as client) and a PAC Control strategy or a Node-RED flow (acting as a server).
- To enable secure communications through Sparkplug.

To upload a public key certificate, you must make sure that it is stored on a computer or mobile device that can connect to your *groov* RIO.

1. Log into your *groov* RIO with a user ID that has administrator privileges.
2. Click Security > Client SSL.
3. In the Public Certificates window, click Add/Update.

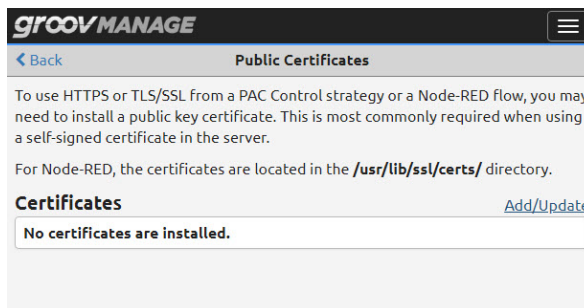

4. Navigate to the folder where you stored the certificate and select the certificate (.pem) file.
5. Click Open. *groov* Manage uploads the file and you'll see it listed in the Certificates section.

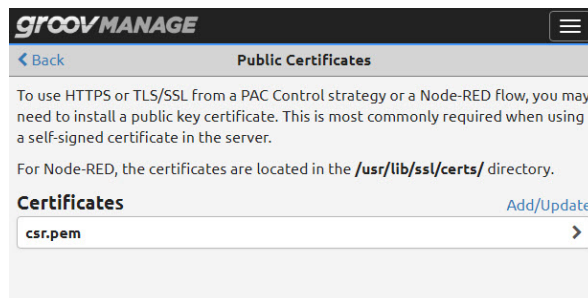

If you need to upload another certificate, repeat steps 3 through 5.

Changing SSL Security Features for Sparkplug

If you are using Sparkplug with MQTT to publish data from *groov* RIO, you must first create and install a CA-signed Certificate on RIO.

- For instructions on creating the certificate, see “Switching to a CA-signed Certificate” on page 25.
- For instructions on installing the certificate on the processor, see “Uploading a Public Key Certificate” on page 26.

After you installed the certificate(s):

1. Log into your *groov* RIO with a user ID that has administrator privileges.
2. Click MQTT > Configuration.
3. For each MQTT Broker that you have listed on the MQTT page and for which you want to enable SSL:
 - a. Click the broker name to open its MQTT Broker settings window.

- b. Move the slider to the right so that it shows green (). *groov* Manage displays a new row below the SSL row.

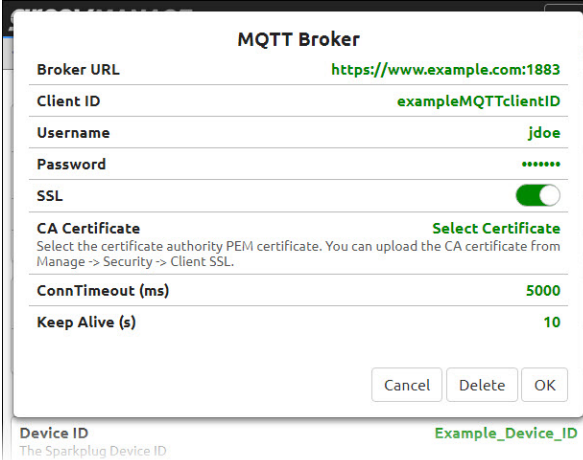

- c. Click Select Certificate. *groov* Manage displays the CA Certificate window with a list of public key certificates installed on the processor. Select the certificate you want.

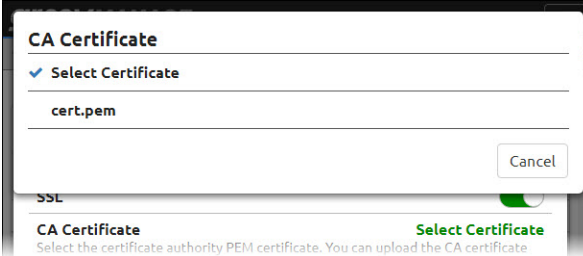

groov Manage refreshes the MQTT Broker settings window to show the name of the certificate you chose.

- d. Click OK.
4. When you are done modifying all the MQTT Brokers that you wanted to change, click Save.

If there are any errors in any of changes you made, *groov* Manage highlights the broker with the error in red. Select that broker to view more information about the errors. Make any necessary changes and try saving again.

CONFIGURING THE FIREWALL

You might be accustomed to hearing or reading about firewalls to protect corporate networks, home networks, and even individual computers. *groov* RIO also contains firewall technology to protect it from unauthorized connections and communication.

Before you configure the firewall on RIO, make sure you understand the following:

- Firewall rules and how they work.
- If you need to create a new rule, you need to know the protocol you want to select (TCP, UDP, or both) and the port number, or range of port numbers, to which this rule will apply.
- The default firewall rules. These rules are in the firewall as part of the default factory settings.

Creating a Firewall Rule

When you make changes to the RIO's firewall, the changes take effect immediately. So, make sure you schedule this change during a time that minimizes the impact to your system and users. If necessary, notify your users of this change so they can plan accordingly.

To create a new rule for the firewall:

1. Log into your *groov* RIO with a user ID that has administrator privileges.
2. Click Security.
3. Click Firewall. The Firewall page displays the rules currently in effect and may look similar to this:

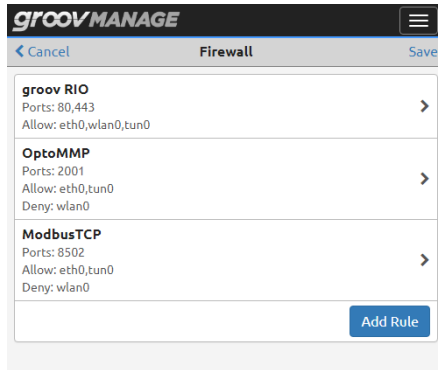

4. Click Add Rule. Type in information for the new rule:
 - **Title**—This will display as a new section title, which has limited space. A title of less than 30 character fits well in the space.
 - **Protocol**—Select which protocol this rules applies to.
 - **Port**—Type in the port number or port number range. Specify a port range by typing in the first port number in the range, followed by a colon, then the last number in the port range, with no spaces between the numbers and the colon.
 - **eth0, wlan0, or tun0**—Select which port this rule applies to by moving the slider to the right so that it shows green ().

- Click OK. If there are any errors in your selections *groov* Manage highlights the error and displays an error message.

test

Title **test**

Protocol **tcp**

Port **22**
Reserved for Opto rules

Add Port *Optional*
port or port:range

eth0

eth1

wlan0

Cancel Delete OK

Deny: eth1

Add Rule

Fix the error or errors and then click OK.

- Repeat the previous two steps for any additional rules you want to create.
- Click Save. *groov* Manage displays a message that it is configuring the firewall.



After *groov* Manage finishes saving and implementing the changes, it displays the Security page.

Please note that adding or changing firewall rules (which effectively opens ports in the firewall) does not start the listening services that may or may not be behind those ports. If you encounter problems accessing those services, check that the services are on and listening.

Changing a Firewall Rule

When you make changes to *groov* RIO's firewall, the changes take effect immediately. So, make sure you schedule this change during a time that minimizes the impact to your system and users. If necessary, notify your users of this change so they can plan accordingly.

To change a firewall rule:

- Log into your *groov* RIO with a user ID that has administrator privileges.

CONFIGURING THE FIREWALL

2. Click Security > Firewall. The Firewall page displays the rules currently in effect and may look similar to this:

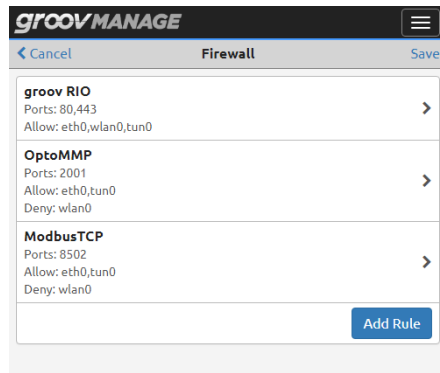

3. Click or tap on the rule you want to change.
4. Make changes.
5. Click OK. If there are any errors in your changes, *groov* Manage highlights the error and displays an error message.

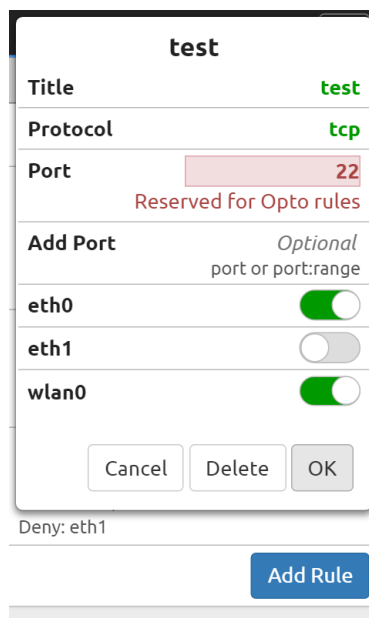

Fix the error or errors and then click OK.

6. Click Save. *groov* Manage displays a message that it is configuring the firewall. If there are any conflicts with existing rules, *groov* Manage will highlight the row with the conflict and then you can change the rule to eliminate the conflict.



After *groov* Manage finishes saving and implementing the changes, it displays the Security page.

Please note that adding or changing firewall rules (which effectively opens ports in the firewall) does not start the listening services that may or may not be behind those ports. If you encounter problems accessing those services, check that the services are on and listening.

6: Connecting *groov* RIO to a Network or Multiple Networks

The topic of networking can be complex. In this chapter, we cover the following scenarios:

- Connecting *groov* RIO to a local area network, either wired or wireless.
- Connecting *groov* RIO to a virtual private network (VPN).

Network configuration changes will require a restart of the network connections on RIO. It's important to have *groov* Find ready to help you locate your RIO on the network. If you are not familiar with *groov* Find, see ["Downloading and Running *groov* Find" on page 100](#). Schedule this task at a time that minimizes the impact on your application and equipment.

If you have an IT department, work with them as you complete these steps:

1. Review your current networking requirements and practices, as well as *groov* RIO's networking capabilities and default settings. Decide whether the default network settings are sufficient for your network or if you need to change some of the defaults. For more information, see ["Reviewing RIO's Network Capabilities and Default Settings" on page 34](#).
2. If you'll be changing the default network settings or connecting to a virtual private network with OpenVPN, gather up and verify the information you need before you begin changing settings. See ["Collecting Network Configuration Information" on page 38](#).
3. Configure the appropriate network interfaces (ETH0, WLAN0) on your *groov* RIO with the information you collected from the previous step. See ["Configuring the Network Interfaces" on page 42](#).
4. If you are connecting to a virtual private network with OpenVPN, configure the OpenVPN Tunnel 0 interface as described in ["Connecting to a Virtual Private Network \(VPN\)" on page 44](#).
5. Test your network connections and fine-tune your security. See ["Testing the Network Connections and Fine-Tuning Security" on page 46](#).

REVIEWING RIO'S NETWORK CAPABILITIES AND DEFAULT SETTINGS

You can connect *groov* RIO to up to three different networks:

- Wired communications through either ETH0 or ETH1. Note that you can't connect two different networks through these interfaces; RIO has switched Ethernet interfaces, not independent Ethernet interfaces.
- Wireless communication, through an approved USB WiFi adapter connected to the USB port. For a list of approved adapters, see ["Installing an Approved USB WiFi Adapter"](#) on page 95.
- A virtual private network (VPN), connected through either ETH0, ETH1, or WLAN0.

WLAN0 is physically separated from ETH0/ETH1, which means there is no communication or routing between the wired and wireless networks.

You can configure the network interfaces to connect to several networks in a variety of combinations. For example:

- Configure ETH0 to connect to a local control network and configure WLAN0 to connect to a local office network.
- Configure ETH0 to connect to a local network, configure OpenVPN Tunnel 0 to connect to a virtual private network, and leave WLAN0 alone or, for enhanced security, disable it.
- Configure ETH0 to connect to your local control network and configure WLAN0 to connect to the Internet.

In addition, you can *daisy-chain* RIOs: connect several RIOs through their wired network interfaces to form a chain. The primary advantage of daisy-chaining is that you save the expense of network routers or switches. The primary disadvantage is similar to that of a serial network: if communication with one RIO is lost, communication to all RIOs beyond it on the daisy-chain are also lost. If you do decide to daisy-chain RIOs, keep in mind the following:

- When you update firmware on RIOs in the chain, you must update them one at a time.
- You cannot daisy-chain RIOs through WLAN0, the wireless network interface.
- Never form a loop or ring with a chain of RIOs. As a rule, do not connect the second interface on the last RIO on the chain to any other device.
- You cannot daisy-chain RIOs powered through PoE. All the RIOs in the chain must be powered with a 10-32 V DC power supply.

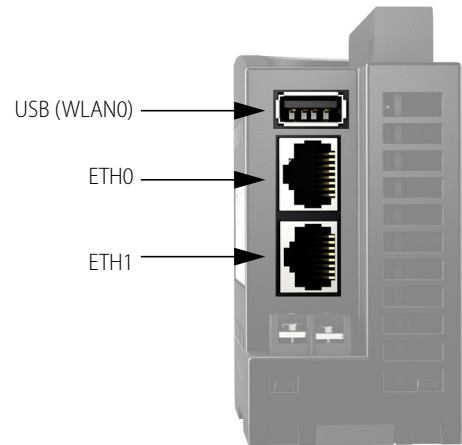

The following illustrations show the correct and incorrect way to daisy-chain RIOs:

CORRECT DAISY-CHAIN CONNECTIONS

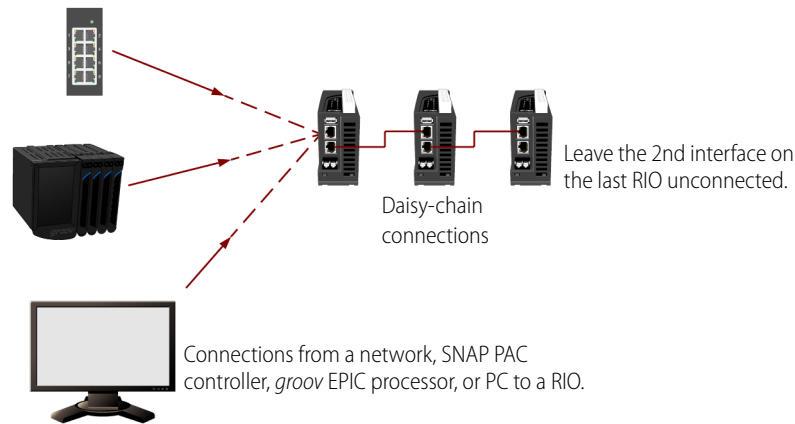

INCORRECT DAISY-CHAIN CONNECTIONS

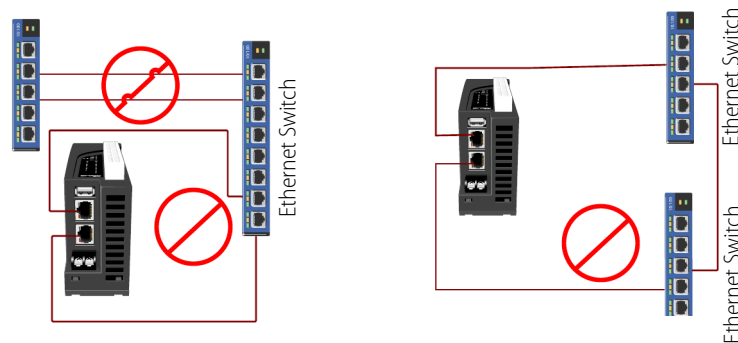

Understanding RIO's Default Network Configuration

When you take it out of the box, *groov* RIO is ready to automatically connect to a network by plugging an Ethernet cable into ETH0 or ETH1. This works most directly in a network that is simple (for example, a computer and a few devices) and that has a DHCP server that manages IP addresses.

If your *groov* RIO will be running in this type of networking environment, review [“Initializing with a Wired Connection” on page 36](#). You can probably skip over the rest of the information in this chapter. However, if you think you might need to change this configuration:

1. Review these two sections to understand two important network operations of *groov* RIO:
 - [“Initializing with a Wired Connection” on page 36](#)
 - [“Keeping Networks Separate” on page 36](#)
2. Read through [“Reviewing Your Network Requirements” on page 36](#) (with your IT department, if you have one) to understand all the important choices you may have to make so that RIO can work in your networking environment.
3. Collect the information you need, based on the choices you made in the previous step. (See [“Collecting Network Configuration Information” on page 38](#).)
4. Make the changes to RIO (see [“Configuring the Network Interfaces” on page 42](#).)

Initializing with a Wired Connection

When you *initialize* your RIO, you must connect it to a network through either ETH0 or ETH1, which means a wired network connection. (For more information about initialization, see [Chapter 3: Initializing a groov RIO](#).) So, plan on using RIO right out of the box with a wired network connection. After you finish all the initialization (which can include configuring the network interfaces for other types of network connections), you'll switch to the networking configuration you want.

If, with your new network configuration, you won't be using some of your network interfaces, you may want to disable them to prevent unauthorized access to your RIO. However **do not** disable those network interfaces until you have **verified** that your new network configurations works; if you don't test it, you may end up with a RIO that is inaccessible (including through *groov* Find) and you will have to reset it to factory defaults.

To disable a network interface:

1. From the *groov* Manage Home page, click System > Network.
2. Click Configure.
3. For the network interface(s) you aren't using, click IPv4 Method, then select Disabled.
4. Click Save. *groov* Manage will save the changes and restart the network connections.

Keeping Networks Separate

Each network interface must be connected to a separate network. Make sure that the wireless access point (SSID) that you select for WiFi is not on the same network as ETH0.

REVIEWING YOUR NETWORK REQUIREMENTS

In a simple network, a DHCP server assigns the following to any new device that joins the network:

- IP address
- Subnet mask
- DNS server: IP address and domain name
- Gateway IP address

With simple applications and networks, having the DHCP server manage these assignments is usually sufficient. Out of the box, *groov* RIO is designed to work with this type of network. If your application and network fall into this category, review "[Choosing between Automatic and Manual Connections](#)" (below).

However, for certain applications or in some complex networking environments, you may want *groov* RIO to override or ignore the information it receives from the DHCP server.

- **Example 1**—Your IT department may want to assign your RIO a static IP address and subnet mask.
- **Example 2**—Your IT department may want to assign a specific gateway address, or DNS server IP address and domain name to a network interface (ETH0, WLAN0, or OpenVPN Tunnel 0).
- **Example 3**—Your IT department may want to route traffic leaving *groov* RIO through a specific path.

These examples illustrate why it is important to work with your IT department (if you have one) before connecting your *groov* RIO to a complex network. Review the information in the rest of this section with your IT department. As you review the information, you'll be collecting information that you'll need when it's time to configure the network interfaces. Instructions on what information you need to collect are in "[Collecting Network Configuration Information](#)" on page 38.

Choosing between Automatic and Manual Connections

For each physical network interface on a *groov* RIO that you are connecting to a network, you can choose one of two connection methods:

- **Automatic**—The DHCP server assigns the IP address and subnet mask. Select this method if:
 - Your network is simple and small with a DHCP server.
 - The default network settings on *groov* RIO meet the needs of your network environment.
 - The default network settings meet your networking requirements and you plan to add a wireless adapter.
 - The DHCP server can assign the IP address and subnet mask, but you want to be able to override the gateway address or DNS IP address and name server.
 For any of these situations, review [“Collecting Information for Automatic Connections” on page 38](#).
- **Manual**—You or the IT administrator need to enter an IP address, a subnet mask, and, in the cases described below, additional configuration information. Select this method if you or your IT department require advanced network configurations.

Implementing Advanced Networking Requirements

For the unique cases described earlier, review the information below. Most of these options are available on all the network interfaces (ETH0, WLAN0, and OpenVPN Tunnel 0).

- If you need to override the DNS server IP address and domain name assigned by the DHCP server, see [“Overriding the DNS Server IP Address and Domain Name Assigned by DHCP Server”](#) (below).
- If you need to do either of the following, see [“Adding DNS Servers and Specifying the Order in which DNS Servers are Queried”](#) (below):
 - Add more DNS server IP addresses and domain names.
 - Specify the order in which the DNS servers are added to the DNS resolver’s configuration.
- If you need to do either of the following, see [“Adding Gateway IP Address or Overriding the Gateway IP Address Assigned by the DHCP Server”](#) (below):
 - Add a gateway IP address or override the gateway IP address assigned by the DHCP server.
 - Alter the order in which gateways are invoked. Gateway Order determines which interface’s gateway is used for off-subnet destination-based routing. The gateway associated with the active interface with the lowest gateway order will be used as the default gateway. For more information about this topic, see [“G: Advanced Networking Configurations” on page 247](#).

Overriding the DNS Server IP Address and Domain Name Assigned by DHCP Server. If your network policy is for the DHCP server to assign the IP address and subnet mask, but the IT administrator manually assigns the domain name server (DNS), you will need the IP address and domain name of that server when it’s time to configure *groov* RIO. Record this information [“Table of Additional Gateway IP Addresses, DNS IP Addresses and Name Servers, and Order” on page 40](#) (in the Automatic section, as DNS Server 1 Override and DNS Domain 1 Override, under the network interface that requires this configuration) so that it is readily available when you configure your RIO.

You can specify additional domain name servers, entering them as the second (DNS Server 2 Override with DNS Domain 2 Override) and third (DNS Server 3 Override with DNS Domain 3 Override) entries in the table, also in the Automatic section.

Adding DNS Servers and Specifying the Order in which DNS Servers are Queried. You can assign up to three domain name servers to each network interface on RIO and indicate the order in which to communicate with the servers. You can set the DNS Order of a network provisioning domain to specify the priority that name servers and search domains are added to the DNS resolver’s configuration, which has a maximum limit of three name servers and six search domains. When a DNS request is made, the resolver queries name servers in series in the order defined in the configuration. If a response is received with either a successful resolution or with a reply code such as "Name not found", no other name servers are queried. If the DNS request times out, the next name server is tried until all name servers are exhausted. Be aware that name resolution of secondary and tertiary name servers may be slow due to the sequential nature of queries by the DNS resolver.

COLLECTING NETWORK CONFIGURATION INFORMATION

For each network interface that requires this configuration, make a note of the DNS server IP addresses and domain names in the Automatic section (for network interfaces where you selected Automatic connection) or the Manual section (for network interfaces where you selected Manual connection) of [“Table of Additional Gateway IP Addresses, DNS IP Addresses and Name Servers, and Order”](#). The DNS Order is per network interface, with 1 being the highest priority (the network interface queried first).

Adding Gateway IP Address or Overriding the Gateway IP Address Assigned by the DHCP Server. If your network policy requires the assignment of a specific gateway IP address, review the information in [“Redirecting Traffic Initiated by an Incoming Connection Request” on page 247](#) to understand how *groov* RIO manages gateway assignments and prioritizes their use.

For each network interface that requires this configuration, make a note of the gateway IP address in the Automatic section (for network interfaces where you selected Automatic connection) or the Manual section (for network interfaces where you selected Manual connection) of [“Table of Additional Gateway IP Addresses, DNS IP Addresses and Name Servers, and Order”](#). The Gateway Order is per network interface, with 1 being the highest priority (the network interface queried first).

COLLECTING NETWORK CONFIGURATION INFORMATION

If you will be changing the default network setting or connecting to a virtual private network (VPN), you will want to collect some configuration information from your IT administrator. To help you organize this information and make it quicker to do the configuration, print the following tables and fill them out as you collect the information.

- [“Tables for IP Address, Subnet Mask, and Additional Wireless Settings” on page 39](#)
- [“Table of Additional Gateway IP Addresses, DNS IP Addresses and Name Servers, and Order” on page 40](#)

Save this information in a secure location that you can quickly access and refer to this information when you start following the instructions in [“Configuring the Network Interfaces” on page 42](#).

Collecting Information for Automatic Connections

By default, *groov* RIO connects to networks automatically. If this method adequately meets the needs of your application, then:

- For wired communications, there is no additional information that you need to collect. Fill in the table ([“Tables for IP Address, Subnet Mask, and Additional Wireless Settings”](#)) with “Automatic” in the ETH0 column to remind you that you do not need this information.
- For wireless communications, fill in the IP address and Subnet mask rows of the table with “Automatic”; you don’t need to manually specify an IP address and Subnet mask with Automatic. However, you do need to collect the following information:
 - **SSID**—A text string from 1 to 32 characters that uniquely identifies the wireless network. This should be the name of the wireless network access point you want *groov* RIO to join.
 - **Encryption**—The type of encryption to secure the packets:
 - **None**—Do not encrypt the packets.
 - **WEP**—A wireless security protocol that is not secure and has been deprecated by the Institute of Electrical and Electronics Engineers (IEEE). Do not select WEP for new installations unless it is the only option available. Instead, select WPA or WPA2.
 - **WPA**—Encrypt the packets with TKIP encryption (RC4) and an 8 to 63 digit ASCII or 64 digit hexadecimal key.
 - **WPA2**—Encrypt the packets with CCMP encryption (AES) and an 8 to 63 digit ASCII or 64 digit hexadecimal key.

- **Key Type**—Select one of the following:
 - **Passphrase (ASCII)**—This is the typical key type for WPA.
 - **PSK (HEX)**—This is the typical key type for WEP.
- **Key**—The password *groov* RIO must provide when it tries to join the wireless network.

TABLES FOR IP ADDRESS, SUBNET MASK, AND ADDITIONAL WIRELESS SETTINGS

WIRED		WIRELESS	
ETH0		WLAN0	
IP address		IP address	
Subnet mask		Subnet mask	
		SSID	
		Encryption type	<input type="checkbox"/> None <input type="checkbox"/> WEP <input type="checkbox"/> WPA <input type="checkbox"/> WPA2
		Key type	<input type="checkbox"/> Passphrase (ASCII) <input type="checkbox"/> PSK (HEX)
		Key	Do not write down.

Collecting Information for Manual Connections

If you want to specify network configuration information manually, work with your IT department (if available), and note the following information in the [“Tables for IP Address, Subnet Mask, and Additional Wireless Settings”](#) on page 39:

- **IP Address** and **Subnet Mask**—These two pieces of information work together to create a unique network address. It’s very important that you create a unique network address by assigning each network interface a different IP address and subnet mask. While the IP address must be *different* than any other device *on the same network*, the subnet mask must be the *same* as all other devices *on the same network*. For example:
 - All the devices on network A are assigned a subnet mask of 255.255.0.0.
 - All the devices on network B are assigned a subnet mask of 255.0.0.0.
 If you connect the processor to network A, make sure to specify 255.255.0.0 as the subnet mask.
- For wireless communications, in addition to the IP address and subnet mask, you need to collect the **SSID**, **Encryption**, **Key Type**, and **Key**, as described [“Collecting Information for Automatic Connections”](#) on page 38.

If you are also configuring the network interfaces for the complex scenarios described in [“Implementing Advanced Networking Requirements”](#) on page 37, that section described what information to collect and where to store in [“Table of Additional Gateway IP Addresses, DNS IP Addresses and Name Servers, and Order”](#) on the next page.

TABLE OF ADDITIONAL GATEWAY IP ADDRESSES, DNS IP ADDRESSES AND NAME SERVERS, AND ORDER

Setting		ETH0	WLAN0	OpenVPN Tunnel 0
Automatic	Gateway Override			
	DNS Server 1 Override			
	DNS Server 2 Override			
	DNS Server 3 Override			
	DNS Domain 1 Override			
	DNS Domain 2 Override			
	DNS Domain 3 Override			
	Gateway Order			
	DNS Order			
Manual	Gateway Address		N/A	N/A
	DNS Server 1			
	DNS Server 2			
	DNS Server 3			
	DNS Domain 1			
	DNS Domain 2			
	DNS Domain 3			
	Gateway Order			
	DNS Order			

Collecting Network Configuration Information for OpenVPN Connection

There are many resources available online to help you learn about and set up a virtual private network (VPN) with OpenVPN technology. This section assumes you have a functioning OpenVPN server. *groov* RIO works as an OpenVPN client that connects to the OpenVPN server. (*groov* RIO cannot be set up as an OpenVPN server.) You'll need the OpenVPN server administrator to provide you with the following:

- A username and password to login to the OpenVPN server.
- If necessary, a username and password for proxy connections.
- Depending on the security and authentication configuration of the OpenVPN server, you may need some or all of these files or information:
 - A public key, also known as a certificate, which is typically available as a file that ends in `.crt`.
 - A private key that is created specifically for your *groov* RIO. It is typically available as a file that ends in `.key`.
 - A Certificate Authority (CA) certificate and key, which helps verify the public and private keys. These are also typically provided in files, with the certificate file that ends in `.crt` and the key file that ends in `.key`.
 - An OpenVPN static key, if required. Not all sites implement OpenVPN static keys. This key is typically stored in a file called `static.key`.
- The following server information:
 - **Protocol**—The communications protocol used by the OpenVPN server.
 - **OpenVPN server hostname** and **port number**—The hostname is usually a fully-qualified domain name (for example, `vpnsrvr.example.com`) or it could be an IP address.
 - **Encryption Cipher**—The encryption cipher used by the OpenVPN server.

- **LZO Compression**—If the OpenVPN server uses LZO compression, then you will need to enable it on your *groov* RIO.

Some of this information can be provided in a configuration file, which you can then upload into your *groov* RIO. Uploading a configuration file could make configuring the processor easier and you will be less likely to introduce typing errors. When you receive the configuration file, review it to make sure it has the following information (and in the format indicated), as appropriate for your OpenVPN server’s security and authentication configuration:

- Certificate Authority (CA)—The CA section should be surrounded by `<ca>` and `</ca>` tags. Inside those tags, the certificate text should be surrounded by `<cert>` and `</cert>` tags.
- Private and Public Key—The key text should be surrounded by `<key>` and `</key>` tags.
- Open VPN static key—The key text should be surrounded by `<tls-auth>` and `</tls-auth>` tags.

If it doesn’t contain this information, you can edit the file and add it, making sure it is surrounded by the tags described previously.

If the administrator can’t provide a configuration file, print the following table to collect the above information, save it in a secure place, and have it handy when you follow the instructions in [“Connecting to a Virtual Private Network \(VPN\)” on page 44](#).

TABLE OF OpenVPN SETTINGS

Information	Value
Protocol	<input type="checkbox"/> udp <input type="checkbox"/> tcp-client
OpenVPN Server Host Name	_____
OpenVPN Server Port Number	_____
Remote Public Certificate Path and File Name	_____
User Name	_____
Password	Do not write down.
Proxy User Name	_____
Proxy Password	Do not write down.
Encryption Cipher	<input type="checkbox"/> none <input type="checkbox"/> _____
LZO Compress	<input type="checkbox"/> yes <input type="checkbox"/> no

CONFIGURING THE NETWORK INTERFACES

1. Log into *groov* RIO with a user ID that has administrator privileges.
2. Click System > Network. *groov* Manage displays the Network status page.

The Network status page shows you the current network configuration, and provides access to the Network configuration page, as well as diagnostic tools.

In the example to the right, RIO is connected to a network through a cable plugged into ETH0. There is no WiFi connection through WLAN0, and no connection to a virtual private network. The values listed in the Network Options section were assigned by the local DHCP server.

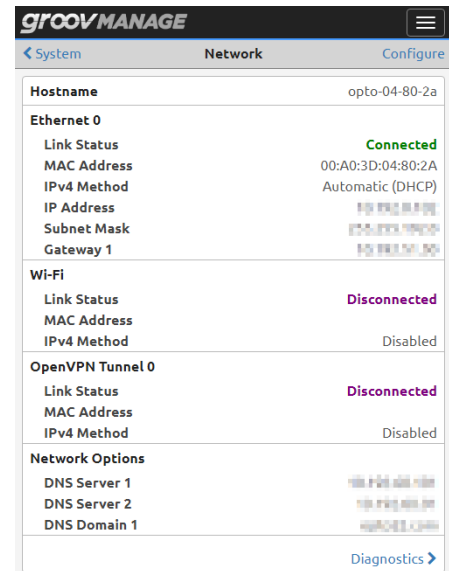

3. Click Configure. *groov* Manage displays the Network configuration page. The example to the right shows the default settings.

Ethernet 0 shows the current settings for ETH0. Wi-Fi shows the current settings for WLAN0.

OpenVPN Tunnel 0 shows the current settings for a virtual private network.

- To configure ETH0 for wired communications, see [“Configuring ETH0” on page 42.](#)
- To configure WLAN0 for wireless communications, see [“Configuring WLAN0” on page 43.](#)

When you are done with all the configurations, go to [“Saving the Configuration” on page 44.](#)

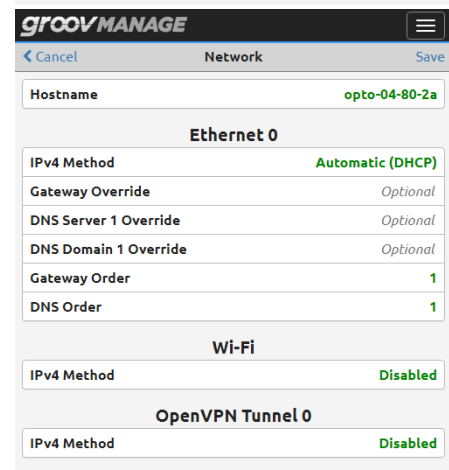

Configuring ETH0

You’ll want to have the information you collected when you read through [“Collecting Network Configuration Information” on page 38](#) available as you follow these steps:

1. From the Network configuration page, click the IPv4 Method currently assigned (the text in green) to ETH0. *groov* Manage displays the IPv4 Method window (see right).
2. Click the connection method you want. If you choose Disable, skip to [step 5.](#)
3. If you selected Automatic and you don’t want to override the DHCP server settings for gateway, DNS address, and DNS name server, skip to [step 5.](#) Otherwise, now is when you enter those override values from [“Table of Additional Gateway IP Addresses, DNS IP Addresses and Name Servers, and Order” on page 40.](#)

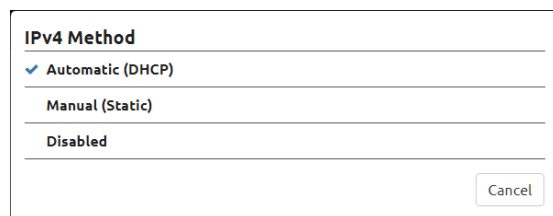

- If you selected Manual, the Network configuration page changes to display additional fields. You'll want to refer to the values you entered in "Table of Additional Gateway IP Addresses, DNS IP Addresses and Name Servers, and Order" to fill out these fields:

- IP Address
- Subnet Mask
- Gateway Address
- DNS Server 1 and DNS Domain 1

These two fields must be specified as a set. If you need to enter more than one set, *groov* Manage displays fields to enter a second and third set after you enter the previous set.

- Gateway Order
- DNS Order

- Choose from the following:

- If you need to configure WLAN0 for wireless communications, go to "Configuring WLAN0" on page 43.
- If you are done configuring the physical network interfaces, go to "Saving the Configuration" on page 44.

Ethernet 0	
IPv4 Method	Manual (Static)
IP Address	10.20.30.40
Subnet Mask	255.255.255.0
Gateway Address	Optional
DNS Server 1	Optional
DNS Domain 1	Optional
Gateway Order	1
DNS Order	1

Configuring WLAN0

- From the Network configuration page, click the IPv4 Method in the Wi-Fi section and select the connection method you want. *groov* Manage updates the Network configuration page as shown below (automatic on the left, manual on the right):

Wi-Fi	
IPv4 Method	Automatic (DHCP)
SSID	Required
Encryption	None
Gateway Override	Optional
DNS Server 1 Override	Optional
DNS Domain 1 Override	Optional
Gateway Order	3
DNS Order	3

Wi-Fi	
IPv4 Method	Manual (Static)
SSID	Required
Encryption	None
IP Address	10.20.30.40
Subnet Mask	255.255.255.0
Gateway Address	Optional
DNS Server 1	Optional
DNS Domain 1	Optional
Gateway Order	3
DNS Order	3

- Enter the information you collected in "Collecting Network Configuration Information" on page 38.
- Choose from the following:
 - If you need to configure a network interface for wired communication, see "Configuring ETH0" on page 42.
 - If you are done configuring the network interfaces, go to "Saving the Configuration" on page 44.

SAVING THE CONFIGURATION

In the Network configuration page, click Save. *groov* Manage displays a message that it will restart the network connections.

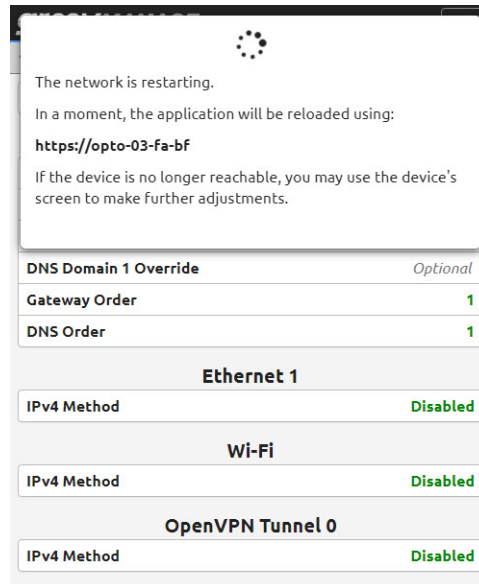

After the network connections are restarted, if *groov* Manage doesn't reappear and you can't access your RIO through any of the network connections you configured, start up *groov* Find to help you locate your RIO (see "Downloading and Running *groov* Find" on page 100).

After you reconnect to your RIO, you can test the network connections and fine-tune your security settings. If you need to set up a virtual private network (VPN), see "Connecting to a Virtual Private Network (VPN)" on page 44.

CONNECTING TO A VIRTUAL PRIVATE NETWORK (VPN)

Before you begin:

- Make sure you've configured at least one physical network interface (see "Configuring the Network Interfaces" on page 42) and that it's functioning.
- Check that you have all the information you collected when you reviewed "Collecting Network Configuration Information for OpenVPN Connection" on page 40.
- Verify that the OpenVPN server is reachable.

Let's begin:

1. From a browser, connect to *groov* RIO and log into *groov* Manage with a user ID that has administrator privileges.
2. If you will be entering the configuration manually (without a configuration file as described in "Collecting Network Configuration Information for OpenVPN Connection" on page 40), upload the public key.
 - a. From the *groov* Manage Home page, click Security > Client SSL.
 - b. Click Add/Update.
 - c. Navigate to the folder where you stored the public key (. crt) file.
 - d. Select the key, then click Open.
3. Click Back > Home to return to the *groov* Manage Home page, then click System > Network.

4. Click Configure.
5. In the OpenVPN Tunnel 0 section, click IPv4 Method and select Automatic (DHCP).

IPv4 Method Disabled

OpenVPN Tunnel 0

IPv4 Method Automatic (DHCP)

Use Configuration Wizard
Guided input for basic client configuration.

Current Configuration >

Gateway Order	255
DNS Order	255

6. Enter the configuration information you collected when you reviewed “Collecting Network Configuration Information for OpenVPN Connection” on page 40.
 - If your VPN information is in a client configuration file, click Upload Configuration File. Navigate to the folder where you stored the configuration file, select it, then click Open. Click Set User Credentials to enter the OpenVPN server user name and password. If necessary, click Set Proxy Credentials to enter the proxy credentials. Go to [step 7](#).
 - If you need to enter the configuration information manually, slide the User Configuration Wizard switch to the right, until it turns green.
 - a. Click Protocol to select the protocol used by your OpenVPN server.
 - b. Enter the IP address or full domain name of the OpenVPN server in the Remote Host field
 - c. To enter the port number, click in the space between the - and + sign. Type in the port number.
 - d. Click Select Certificate and select the certificate you uploaded in [step 2](#) on [page 44](#).
 - e. In the Username and Password fields, type in the OpenVPN server username and password. (Not the proxy username and password.)
 - f. Click Encryption Cipher and select the cipher used by your OpenVPN server from the list.
 - g. If the OpenVPN server uses LZO compression, slide the LZO Compress switch to the right, until it turns green.
 - h. If you need to modify the Gateway and DNS order, click on those numbers and change them.
7. Click Save. If *groov* Manage reports any errors, fix those errors and click Save. Otherwise, *groov* Manage displays a message that it will restart the network connections.

IPv4 Method Disabled

OpenVPN Tunnel 0

IPv4 Method Automatic (DHCP)

Use Configuration Wizard
Guided input for basic client configuration.

Protocol udp

Remote Host Required

Remote Port ⊖ ⊕

Remote Public Cert Select Certificate
Select the certificate authority PEM certificate. You can upload the CA certificate from Manage -> Security -> Client SSL.

Username Required

Password Required

Encryption Cipher None

LZO Compress

Gateway Order 255

DNS Order 255

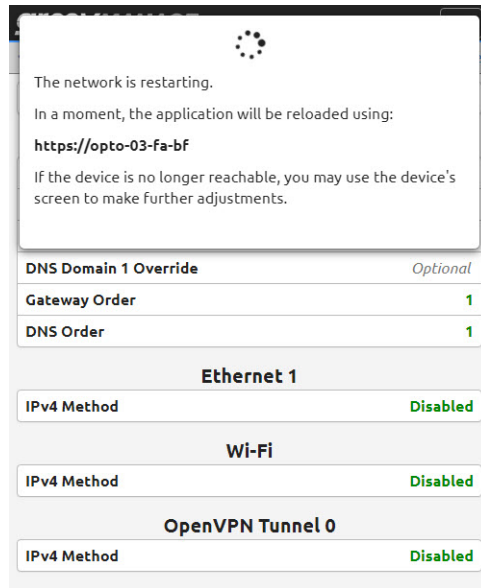

TESTING THE NETWORK CONNECTIONS AND FINE-TUNING SECURITY

To test the network connections, do one of the following:

- If you switched to Automatic, wait a few seconds for RIO to receive an IP address from the DHCP server. The logon page will refresh and display the IP address after it receives it.
- If you switched to Manual, verify that the IP address works by trying to connect to RIO from a web browser. Or, from a Windows computer that's connected to the same network, you can try the ping command in a command prompt window.

If you encounter any issues with ETH0, and WLAN0, see ["Troubleshooting" on page 99](#) for topics regarding network connections. If you are troubleshooting issues with an OpenVPN connection, you can review the VPN client logs for messages. To access the logs, from the *groov* Manage home page, click Info and Help > Logs > OpenVPN Client.

For enhanced security, disable any network interfaces you aren't using.

You may also want to update your security options and firewall settings:

- ["Managing the SSL Security Features of your groov RIO" on page 24](#)
- ["Configuring the Firewall" on page 27](#)

7: Configuring a *groov* RIO

A user with administrator privileges is the only user that can change system features. System features provide services like access control, device management, and time management.

SETTING AND ADJUSTING DATE, TIME, AND TIME ZONES

Setting and adjusting the date, time, and time zones can help you with more than just setting *groov* RIO to the local time:

- You can change the date and time of your *groov* RIO to test time-sensitive features of your control program.
- You can synchronize the clock on your *groov* RIO to any number of time servers from around the world.
- You can specify multiple time servers to function as backups of each other, or specify a device as a time server.

When you turn on your *groov* RIO for the first time and after it establishes network connectivity, it sets the time from a default time server. To see the default time server, from the *groov* Manage Home page, click System > Time. The bottom half of the screen lists the time servers.

groov MANAGE Time Settings

Time

Year	2020
Month	2
Day	20
Hour	0
Minute	20
Second	36

All currently signed-in users may be signed out after setting the time.

Time Zone

Region	Universal
Locality	

Time Servers

Enable NTP	<input checked="" type="checkbox"/>
Time Server 1	0.pool.ntp.org
Time Server 2	1.pool.ntp.org
Time Server 3	2.pool.ntp.org

Sync your clock with servers on the Internet such as 0.pool.ntp.org.



Setting the Date and Time Manually

There might be a few reasons why you want to set the date and time manually instead of synchronizing to time servers:

- You want to test time-sensitive features in your control program, so you want to be able to adjust the date and time to test those features.
- You are working in an environment (for example, a disconnected test environment) where changes in time will not affect production or other critical applications.

Note: *Changing the time manually will log out any users that are currently logged onto your groov RIO. Carefully choose when you will change the time to minimize any adverse effect on other users.*

To set the date and time manually:

1. Log into *groov* RIO with a user ID that has administrator authority.
2. Click System ( System), then Time ( Time).
3. In the Time Servers section, turn off the Enable NTP setting by moving the slider to the left so that it shows grey ().
4. Click Set NTP.
5. In the Time section, select values for Year, Month, Day, Hour, Minute, and Second.
6. Click Set Time. *groov* Manage displays a message while it's setting the date and time. When it finishes, the message disappears.

Now your date and time are set.

IMPORTANT: *If you set the date and time manually, the time will not update for Daylight Savings Time (for those areas that observe Daylight Savings Time). So, you must remember to manually update the date and time during those events.*



Setting the Date, Time, and Time Zone by Synchronizing with Time Servers

If you are not familiar with time servers, you can learn more about them through the NTP Pool Project at www.pool.ntp.org. When you are selecting a time server, remember the following:

- It is a good idea to select a couple of time servers to serve as backups in case *groov* RIO cannot establish a connection to the primary time server or if that time server becomes unavailable. The steps below instruct you to set two additional time servers.
- If you had set your date and time manually, setting the date and time as described in this section will overwrite your manual settings.

Note: *Changing the time manually will log out any users that are currently signed into your groov RIO. Carefully choose when you will change the time to minimize any adverse affect on other users.*



To select the primary time server and a few backups:

1. Log into *groov* RIO with a user ID that has administrator privileges.
2. Click System ( System), then Time ( Time).
3. In the Time Servers section, click Time Server 1. Enter the host name of the time server.
4. Click Time Server 2. Enter the host name of a second time server.
5. Click Time Server 3. Enter the host name of a third time server.
6. Click Set NTP. *groov* Manage displays a message while it's synchronizing with the time servers. When it finishes, the message disappears.

Now your date and time are set, as well as the time zone. The date and time will be updated automatically during the switches between Standard Time and Daylight Savings Time, according to the schedule set by the time servers.

Setting the Time and Time Zone by Selecting a Location

If you want to set the time by selecting your location, do the following steps:

1. Log into *groov* RIO with a user ID that has administrator privileges.
2. Click System (), then Time ().
3. In the Time Zone section, click Region to select a general geographical area of the world.
To set the time for cities or regions in the United States of America, select America as the region. America encompasses North, Central, and South America.
4. Click Locality to select a specific city that most closely approximates the city within the time zone you want to set.
5. Click Set Zone. *groov* Manage displays a message while it's setting the time. When it finishes, the message disappears.

MANAGING THE USB PORT

groov RIO can work with any of the following devices inserted into the USB port:

- USB storage devices. Certain requirements must be met, as described in “Requirements for USB Storage Devices” on page 51.
- USB-to-serial adapters. Only certain adapters are supported. You can find a list at “Connecting Serial Devices” on page 49.
- WiFi adapters. Only certain adapters are supported. For a list, see “Installing an Approved USB WiFi Adapter” on page 55.

If you do not plan on attaching any USB devices, it would be a good security practice to leave the USB port disabled. Disabling the USB port prevents any unauthorized access to RIO through the port. By default, the port is disabled, so if you plan on attaching any of the devices listed above, you need to enable the USB port. :

1. Log into *groov* RIO with a user ID that has administrator privileges.
2. Click System > USB.

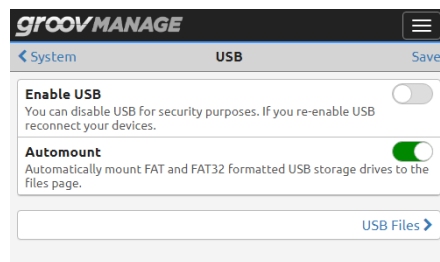

3. Click the Enable USB slider so that it turns green.
4. Click Save. *groov* Manage returns you to the System page. Now you can:
 - Attach a USB storage device (see “Attaching and Detaching a USB Storage Device” on page 51).
 - Connect a serial device(s) (see “Connecting Serial Devices” on page 49).
 - Attach a WiFi adapter (see “Installing an Approved USB WiFi Adapter” on page 55).

CONNECTING SERIAL DEVICES

You can connect serial devices to *groov* RIO by inserting a USB-to-serial adapter into the USB port. Before you attach the adapter, make sure you enabled USB as described in “Managing The USB Port” on page 49.

Note: Only Node-RED flows can access serial devices connected through a USB-to-serial adapter.

The following table lists USB-to-serial adapters supported by *groov* RIO.

Device Manufacturer	Model
B&B Electronics	USOPTL4 (isolated RS-485) USPTL4 (non-isolated RS-485) USO9ML2 (isolated RS-232)
Gearmo	GM-482422 (non-isolated RS-485/RS-422) GM-FTD1-A12 (non-isolated RS-232) SERIAL-B (non-isolated RS-232)

You can expand the number of serial devices you can connect to *groov* RIO by installing a USB hub to the USB port. When you do this, it's important to keep track of the device names and port numbers that *groov* RIO assigns to the USB-to-serial adapter that you plug into each USB port on the hub (see ["Understanding How *groov* RIO Assigns Port Numbers and Device Names When Using a Hub"](#) on page 50). One way to do this is:

1. Go to the Serial Devices page in *groov* Manage (Home > System > Serial Devices).
2. Insert an adapter into a port. *groov* Manage will detect the adapter, assign it a device name and port number, then refresh the page to show the information.
3. Make note of the device name and port number so that you have it handy as you develop Node-RED flows.

If you move a serial device from one USB port of the USB hub to another port on the hub, *groov* RIO assigns it a new port number, and possibly a new device name. These changes might require changes to your Node-RED flows.

Before you start connecting an adapter of USB hub to your RIO, see ["Managing The USB Port"](#) on page 49.

Device Name and Port Number

groov RIO assigns `/dev/ttySer0` as the device name and 0 as the port number to the USB-to-serial adapter you plug into the USB port. You use the device name and port number in your Node-RED flow to access the serial device.

Understanding How *groov* RIO Assigns Port Numbers and Device Names When Using a Hub

If you connect a USB **hub** to the USB port, *groov* RIO includes a suffix to the device name and port number to identify the port number on the USB **hub**. For example, if you connect a 4-port USB hub to the USB port, then *groov* RIO assigns device names and port numbers as follows:

If a USB-to-serial adapter is plugged into port x of the USB hub...	<i>groov</i> RIO assigns it a device name of...	and a port number of...
1	<code>/dev/ttySer0.1</code>	0.1
2	<code>/dev/ttySer0.2</code>	0.2
3	<code>/dev/ttySer0.3</code>	0.3
4	<code>/dev/ttySer0.4</code>	0.4

IMPORTANT: If you move the adapter from one USB port on the USB hub to another USB port, *groov* RIO will assign a new port number and device name to the adapter. Any Node-RED flow that references the old port number and device name will need to be modified to refer to the new port number and device name.

Finding Device Names and Port Numbers

You can find device names and port numbers through *groov* Manage.

1. Log into your *groov* RIO with a user ID that has administrator privileges.

2. Click the menu button () , then click System.
3. Click Serial Devices. The Serial Devices page shows the device names and port numbers for any USB-to-serial adapter plugged into the USB port.

ATTACHING AND DETACHING A USB STORAGE DEVICE

You can attach a USB storage device to the USB port on *groov* RIO, then use *groov* Manage to copy files to and from its internal storage. Adding a USB storage device can also increase the amount of storage available for file activities like data logging.

Important: *You should store any critical files in the unit's internal storage. Internal storage utilizes a power-fail safe file system that prevents data, file and file system corruption in the event that power is removed. USB storage devices do not utilize a power-fail safe file system.*

Requirements for USB Storage Devices

groov RIO supports reading and writing to USB storage devices formatted in either FAT or FAT32 file systems. This means that *groov* RIO can not access partitions larger than 32 GB. If you want to read and write to a USB storage device that is larger than 32 GB, you must format (with a computer) that USB storage device with multiple FAT32 partitions. *groov* RIO will be able to read and write to all of the partitions on a properly formatted USB storage device.

Understanding How *groov* RIO Handles USB Storage Devices

In addition to the disabling the USB port (see “*Managing The USB Port*” on page 49), *groov* RIO provides another setting that helps manage security issues when dealing with USB storage devices: **Automount**. When this setting and **Enable USB** are enabled, when you attach a USB storage device, *groov* Manage has immediate access to its content. If you disable Automount (but leave Enable USB enabled), you will have to go through some extra steps to give *groov* Manage access to the content of a storage device.

Reviewing Security Issues with USB Storage Devices

If you do attach a USB storage device, keep the following points in mind:

- Because there is no mechanism to physically secure (or lock) the USB storage device to *groov* RIO, it can be removed by anyone that has access to the unit. It's important to apply important security practices, like keeping the unit secured under lock and key and providing the key to only trusted individuals.
- To prevent someone from inserting an unauthorized USB storage device that could contain malicious software, the Enable USB setting is disabled by default. Carefully consider the security risks before enabling this setting for an extended period of time.

Disabling Access to USB Storage Devices

If you do not plan on using USB storage devices, it would be a good security practice to disable the ability to access USB storage devices. You can still use the USB port for other devices, like supported USB-to-serial adapters or WiFi adapters.

1. Log into your *groov* RIO with a user ID that has administrator privileges.
2. From the *groov* Manage Home page, click System > USB.
3. If you have a USB storage device plugged into *groov* RIO, unmount it.
 - a. Click USB Files.

ATTACHING AND DETACHING A USB STORAGE DEVICE

- b. Click Safely Remove. *groov* Manage displays the following message; click OK to continue:

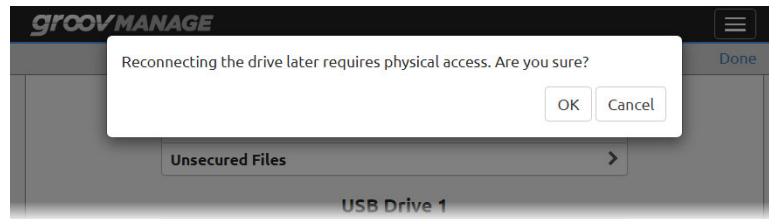

- c. When *groov* Manage successfully unmounts the storage device, it displays the following message. Click Close to continue.

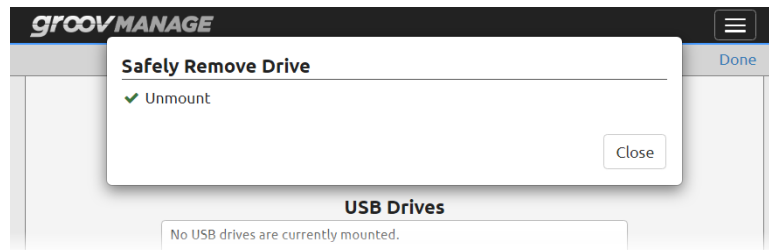

4. Click the Automount slider so that it turns gray ().
5. Click Save. *groov* Manage displays the System page.
groov Manage no longer has automatic access to the contents of a USB storage device inserted into the USB port. However, as long as Enable USB is enabled, it can work with USB-to-serial adapters and WiFi adapters.

Attaching a USB Storage Device

Before you attach a USB storage device, make you understand:

- "Requirements for USB Storage Devices" on page 51
- "Reviewing Security Issues with USB Storage Devices" on page 51

Also, make sure you have Enable USB (see "Managing The USB Port" on page 49) and Automount (see "Understanding How groov RIO Handles USB Storage Devices" on page 51) enabled.

Insert the USB storage device into the USB port. To verify that *groov* Manage has access to the USB storage device, from the *groov* Manage Home page, click System > Files. *groov* Manage displays the Files page. *groov* Manage lists the USB storage device in a section called USB Drive, typically followed by a number:

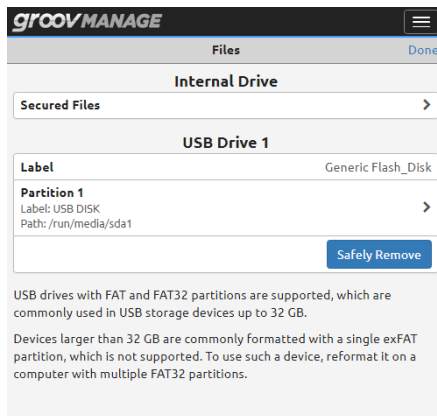

You can now copy, move, and download files (see “Copying, Moving, or Downloading a File on a USB Storage Device” on page 54).

Detaching a USB Storage Device

Before you detach a USB storage device, evaluate the consequences; for example, would it cause an interruption to your data logging process? After evaluating the consequences and taking measures to mitigate those consequences, unmount the device and then remove it.

1. Log into your *groov* RIO with a user ID that has administrator privileges.
2. From the *groov* Manage Home page, click System > USB, then USB Files.
3. Click Safely Remove.

If *groov* Manage detects that a file on the USB storage device is still being used by a service, it will not proceed. One likely service that might be using the storage device is a Node-RED flow that is logging data to the storage device. Check any services that might be using the storage device.

Otherwise, *groov* Manage displays the following message, which reminds you that if you want to reconnect the storage device in the future, you will have to physically reinsert it. Click OK to continue:

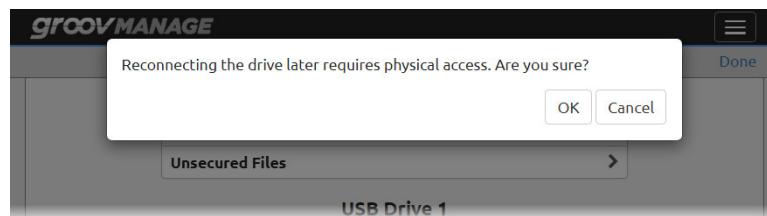

ATTACHING AND DETACHING A USB STORAGE DEVICE

When *groov* Manage successfully unmounts the storage device, it displays the following message. Click Close to continue.

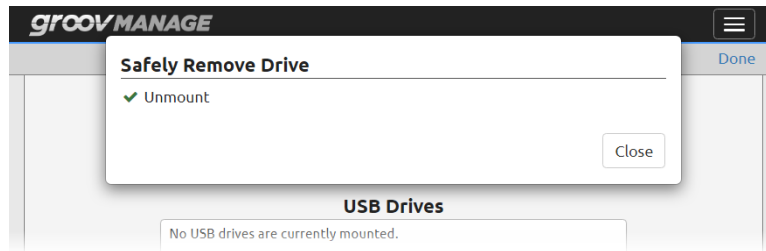

4. Click Done in the Files page.
5. Physically remove the USB storage device from the USB port.
6. Verify that the device no longer shows up in *groov* Manage.

If you do not plan on attaching USB storage devices for an extended amount of time, disable Automount to prevent *groov* Manage from automatically accessing content on any storage device inserted into the USB port (see “[Reviewing Security Issues with USB Storage Devices](#)” on page 51).

Copying, Moving, or Downloading a File on a USB Storage Device

Before you begin, make sure you have properly mounted the USB storage device as described in “[Attaching a USB Storage Device](#)” on page 52.

- Copy and move means to transfer a file from the USB storage device to *groov* RIO’s internal storage.
- Download means to transfer a file from the USB storage device to your computer or mobile device.

These instructions describe how to copy, move, or download one file at a time.

1. Log into your *groov* RIO with a user ID that has administrator privileges.
2. From the *groov* Manage Home page, click System > USB, then USB Files.
3. Click on Partition 1, or, if you have multiple partitions on the USB storage device, scroll to the correct partition and click the partition name.
4. In the Dir Listing section, navigate to the folder that has the file you want to copy, move, or download.
5. Click on the file name. *groov* Manage displays a list of all the actions you can take on the file:

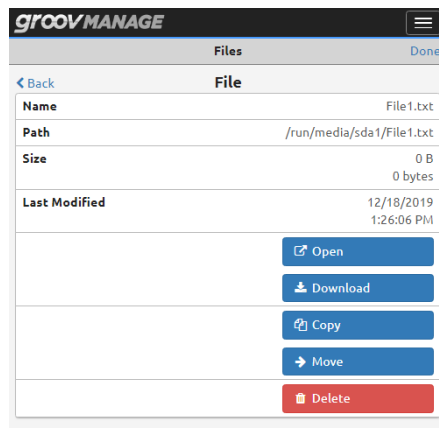

- To copy a file to RIO’s internal storage, click Copy.
- To move a file to RIO’s internal storage, click Move.

- To download a file to the computer or mobile device, click Download.
6. Click Back (top left).
- If you need to copy, move, or download another file, repeat [step 4](#) and [5](#).
 - If you are done copying, moving, or downloading files, click Done (top right corner). *groov* Manage returns you to the USB page.

INSTALLING AN APPROVED USB WIFI ADAPTER

If you want to connect your *groov* RIO to a wireless network, Opto 22 recommends that you purchase and install one of the following USB WiFi adapters, which Opto 22 has tested and verified works with *groov* RIO. Unverified WiFi adapters should not be used.

Device Manufacturer	Model
Linksys	AE6000
TP-Link	Archer T1U
Sabrent	AC600

Collect the following information before starting:

- SSID of the wireless network.
- Encryption method required to access the wireless network.

If you are manually assigning an IP address, make sure you also have the IP address and subnet mask you want to assign to the unit.

Also, make sure you have enabled the USB port (see [“Managing The USB Port”](#) on page 49).

1. Log into your *groov* RIO with a user ID that has administrator privileges.
2. Insert the WiFi adapter into the USB connector on the bottom of the unit.

Note: If you have a USB storage device inserted into the port, make sure you remove it according to the instructions in [“Detaching a USB Storage Device”](#) on page 53.

Bottom View

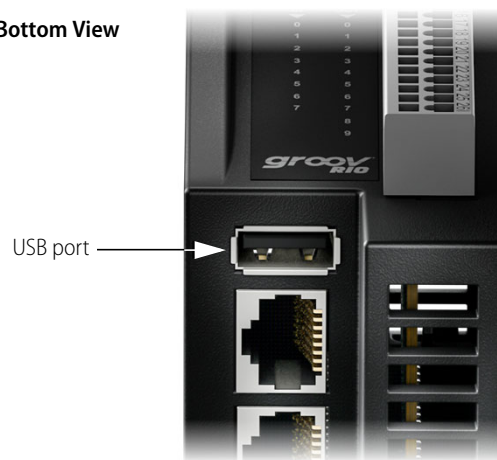

3. In *groov* Manage, go to the Network page (Home > System > Network). If the Wi-Fi section of the Network page now has a MAC Address, then *groov* RIO is communicating with the WiFi adapter.

ENABLING Node-RED

No WiFi adapter inserted; no MAC address	WiFi adapter installed; MAC address available																																
<table><tr><td>Subnet Mask</td><td>192.168.1.0/24</td></tr><tr><td>Gateway 1</td><td>192.168.1.1</td></tr><tr><td>Wi-Fi</td><td></td></tr><tr><td>Link Status</td><td>Disconnected</td></tr><tr><td>MAC Address</td><td></td></tr><tr><td>IPv4 Method</td><td>Disabled</td></tr><tr><td>OpenVPN Tunnel 0</td><td></td></tr><tr><td>Link Status</td><td>Disconnected</td></tr></table>	Subnet Mask	192.168.1.0/24	Gateway 1	192.168.1.1	Wi-Fi		Link Status	Disconnected	MAC Address		IPv4 Method	Disabled	OpenVPN Tunnel 0		Link Status	Disconnected	<table><tr><td>Subnet Mask</td><td>192.168.1.0/24</td></tr><tr><td>Gateway 1</td><td>192.168.1.1</td></tr><tr><td>Wi-Fi</td><td></td></tr><tr><td>Link Status</td><td>Connected</td></tr><tr><td>MAC Address</td><td>30:23:03:D9:22:FD</td></tr><tr><td>IPv4 Method</td><td>Disabled</td></tr><tr><td>OpenVPN Tunnel 0</td><td></td></tr><tr><td>Link Status</td><td>Disconnected</td></tr></table>	Subnet Mask	192.168.1.0/24	Gateway 1	192.168.1.1	Wi-Fi		Link Status	Connected	MAC Address	30:23:03:D9:22:FD	IPv4 Method	Disabled	OpenVPN Tunnel 0		Link Status	Disconnected
Subnet Mask	192.168.1.0/24																																
Gateway 1	192.168.1.1																																
Wi-Fi																																	
Link Status	Disconnected																																
MAC Address																																	
IPv4 Method	Disabled																																
OpenVPN Tunnel 0																																	
Link Status	Disconnected																																
Subnet Mask	192.168.1.0/24																																
Gateway 1	192.168.1.1																																
Wi-Fi																																	
Link Status	Connected																																
MAC Address	30:23:03:D9:22:FD																																
IPv4 Method	Disabled																																
OpenVPN Tunnel 0																																	
Link Status	Disconnected																																

Note, however, WiFi is disabled. The next step is to enable WiFi.

4. Click Configure (top right corner of the Network page).
5. In the Wi-Fi section, click Disabled.
6. In the IPv4 Method window, click the connection method you want: Automatic (DHCP) or Manual.
7. Enter the information you collected.
8. Click Save. Read the message that *groov* Manage displays and click OK. After *groov* Manage verifies the information and saves the configuration, it displays the network page.

Subnet Mask	192.168.1.0/24
Gateway 1	192.168.1.1
Wi-Fi	
Link Status	Connected
SSID	doc
MAC Address	30:23:03:D9:22:FD
IPv4 Method	Automatic (DHCP)
IP Address	192.168.1.10
Subnet Mask	192.168.1.0/24
Gateway 2	192.168.1.1
OpenVPN Tunnel 0	
Link Status	Disconnected

groov RIO is now connected to your wireless network.

ENABLING Node-RED

Node-RED is an open-source, multi-platform software program, where you connect (*wire*) together devices, databases, cloud applications, and APIs (application programming interfaces) to create simple logic flows to accomplish specific goals. It is pre-installed on your *groov* RIO; you do not have to download and install it on a computer or embedded device. You just have to enable it, then start creating Node-RED flows. This tight integration also means that some RIO functions, like backup, apply to your Node-RED projects.

By default, Node-RED is disabled. To enable it:

1. Log into your *groov* RIO with a user ID that has system administrator privileges.
2. In the *groov* Manage Home page, click Node-RED.
3. Click Enable. After the Status field says Running, wait a few seconds before opening the Node-RED Editor.

UPLOADING FILES TO RIO'S INTERNAL FILE SYSTEM OR USB STORAGE DEVICE

groov RIO identifies files that you upload as "user files". You can store files in:

- The "secured area" of the internal file system, where only services with authentication (for example, a user name and password, or an API key) over a secure protocol (HTTPS) can access the files.
- A USB storage device attached to the USB port of your RIO. Before you attach a USB storage device to the USB port, review "[Managing The USB Port](#)" on page 49 to make sure *groov* Manage can access the storage device.

Note that when you backup your system:

- Only the first 10 MB of files that you uploaded are included in the backup file.
- The files stored on the USB storage device are not included in the backup file.

When *groov* Manage performs a backup, it lists all the files it included into the backup file in the *groov* Manage log file. You can check the log file to determine which other files you need backup by other means. (See “Backing up Your *groov* RIO Settings” on page 91.)

1. Log into your *groov* RIO with a user ID that has administrator privileges.
2. Click System > Files. *groov* Manage displays the Files page.

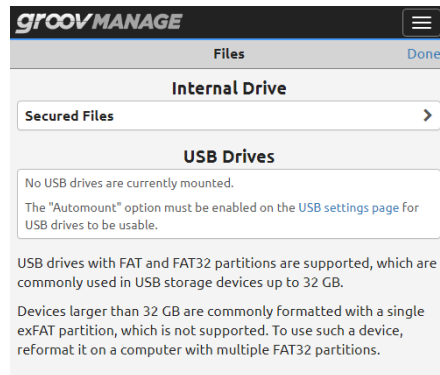

If you had correctly mounted a USB storage device, it would appear in the USB Drives section, like this:

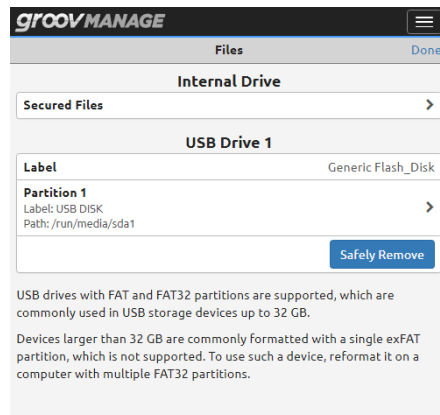

3. Upload a file.
 - To the internal file system**, click Secured Files > Upload File.
 - To the USB storage device**, click the name of the partition where you want to store the file, then click Upload File.
 - a. Navigate to the folder that contains the file you want to upload and select that file.
 - b. Click Open. *groov* Manage uploads the file and then refreshes the Dir Listing section to list the file you just uploaded.
 - c. If you need to upload another file, click Upload File and repeats steps a and b. For USB storage devices, if you need to upload another file to another partition, click Back, select the other partition, click Upload File and then repeats steps a and b.

When you are done uploading files, click **Done**.

8: Configuring I/O

SELECTING FUNCTIONS, SIGNALS, AND FEATURES

Before you can configure your I/O, you need to know which channel is going to serve which function and signal, plus select which features (if available) you need:

- Function: Input or output.
- Signal: Analog or discrete.
- Feature: On State, Off State, Linearization, etc. for those signals that offer features. (For a complete list of features, see [Appendix A: Specifications](#).)

Note that for CODESYS applications, only a limited set of features are available. The instructions will indicate which features are available for CODESYS applications.

If you have not determined this yet, here are a couple of options to help you select the right combination:

- **RIO Explorer**— An Opto 22 web app that can help you select a combination of functions, signal types, and features, and make sure you select channels that can support your choices. When you finish with the RIO Explorer, you can save a wiring diagram, which will come in handy when it's time to wire up your devices. Another way you can use the wiring diagram is to annotate it with specification information like ranges and scaling for analog inputs, or feature selections for discrete inputs. To learn how to use the RIO Explorer, see [Appendix C: groov RIO Explorer](#).
- **Reviewing spec tables, feature tables, and wiring diagrams**—Review the information in [Appendix A: Specifications](#) and [Appendix B: Wiring Diagrams](#) as you follow these steps:
 - a. Review the features table to select which function, signal type, and, if applicable, which feature you want for each channel. If you are working with CODESYS Development System, check the table on [page 68](#) for the list of features supported in that environment. You might find it helpful to note your selections in a table like the one on the following page:

SELECTING A METHOD FOR CONFIGURING I/O

Function (Input or Output)	Signal Type (Analog or Discrete)	Feature (if applicable)	Default Values or Specific Settings (if applicable)
Channel 0			
Channel 1			
Channel 2			
Channel 3			
Channel 4			
Channel 5			
Channel 6			
Channel 7			
Channel 8			
Channel 9			

- b.** For each channel, check the corresponding section of the specification table and verify that you've correctly selected everything. For example, if you selected a discrete input with a counter feature for channel 0, go to the "Discrete Counter Input" section of the chart and verify that channel 0 is within the range listed for "Available Channels". Also check that the signal that is coming in (for inputs) or leaving (for outputs) meets the specifications listed.
- c.** Review the wiring diagrams and check for any additional requirements; for example, any fusing requirements. It may be helpful to print relevant wiring diagrams and annotate them with information you collected in the previous two steps or additional information you may need when it's time to wire your field devices.

Taking the time to check your selections will make it less likely that you'll run into trouble later on, and save you time.

SELECTING A METHOD FOR CONFIGURING I/O

There are several ways to configure I/O. For whichever way you select, you'll want to have the information you collected in "Selecting Functions, Signals, and Features" on page 59 handy. This information can speed up the configuration process.

- *groov* Manage: If you are using your RIO unit as an edge node, where you'll just be transmitting tags to a cloud service through MQTT or through Node-RED flows, you'll want to configure your I/O through *groov* Manage (see "Configuring I/O Through *groov* Manage" below).
- PAC Control: If you are adding your RIO as an I/O unit to a PAC Control strategy, you'll want to follow the instructions in the *PAC Control User's Guide* (form 1700) instead of the instructions in this chapter.
- CODESYS Development System: If you are adding your RIO as a remote I/O unit to a CODESYS application, you'll want to follow the directions in "Configuring I/O Through CODESYS Development System" on page 63.
- OptoMMP: You'll want to review the *OptoMMP Protocol Guide* (form 1465) to learn the memory map locations used for I/O configuration.

Note: You cannot use these methods in combination. Any configuration you make through one method can overwrite configurations made through another method.

CONFIGURING I/O THROUGH *groov* MANAGE

1. Log into your *groov* RIO with a user ID that has administrator privileges.

2. From the *groov* Manage Home page, click I/O Channels. The I/O Channels page displays a quick summary of any channel configurations. If you are configuring channels for the first time, the page looks like this:

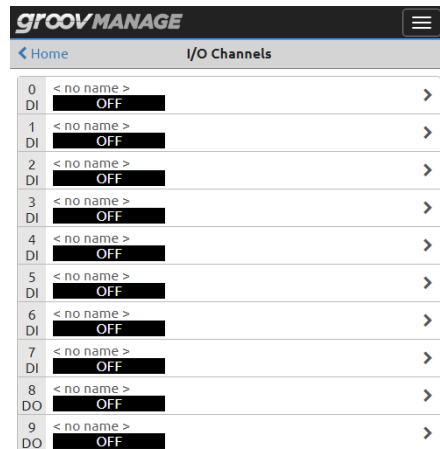

groovMANAGE		Home	I/O Channels
0	< no name >		>
DI	OFF		
1	< no name >		>
DI	OFF		
2	< no name >		>
DI	OFF		
3	< no name >		>
DI	OFF		
4	< no name >		>
DI	OFF		
5	< no name >		>
DI	OFF		
6	< no name >		>
DI	OFF		
7	< no name >		>
DI	OFF		
8	< no name >		>
DO	OFF		
9	< no name >		>
DO	OFF		

3. With each channel, do the following:
 - a. Click a channel.
 - b. Click Configure.
 - c. Assign a Name to help you quickly and uniquely identify this channel and to help you differentiate it from other channels that might be configured similarly. This is optional.
 - d. Click Channel Type and select a value. Review the information you collected for that channel to select the correct one.

Depending on the channel type you select, *groov* Manage may change the content of channel page. The following images show a few examples of how the page changes depending on the channel type you select:

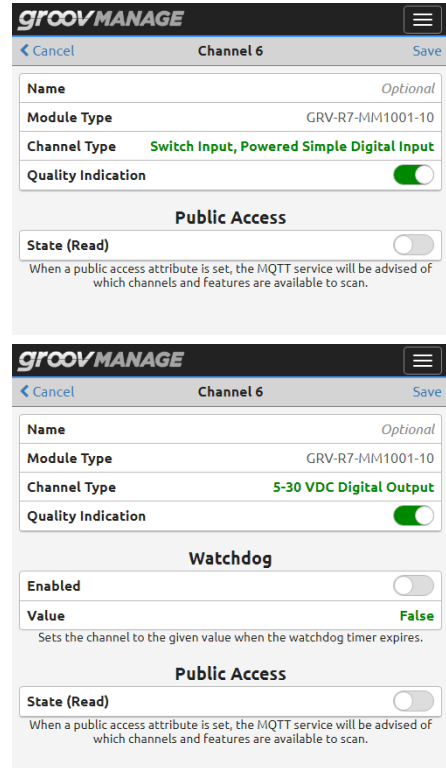
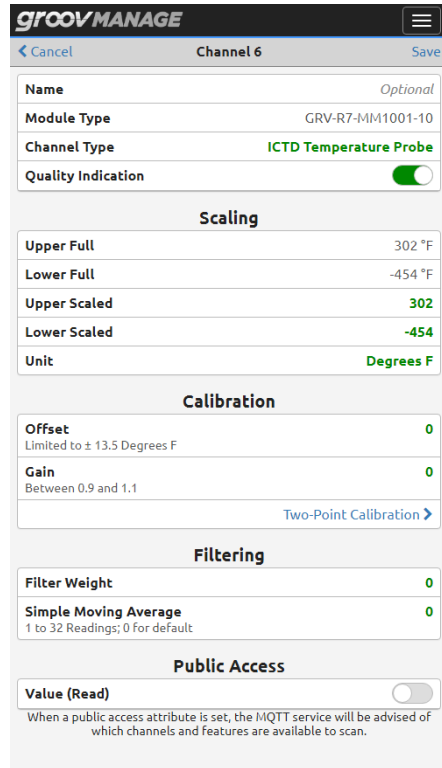

- e. If you are transmitting values through MQTT, you want to enable the Value (Read) switch in the Public Access section. When you do, *groov* Manage displays another set of switches to help you identify the specific values you want available to send, as well as whether to make them writable.

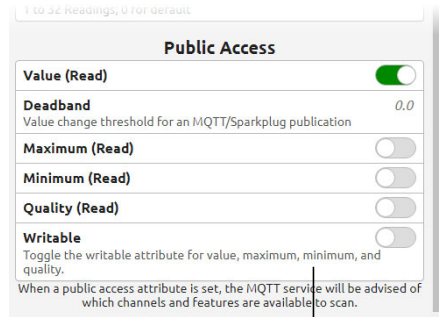

ICTD Temperature Probe

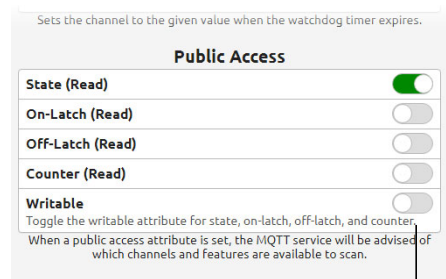

Switch Input, Powered Simple Digital Input

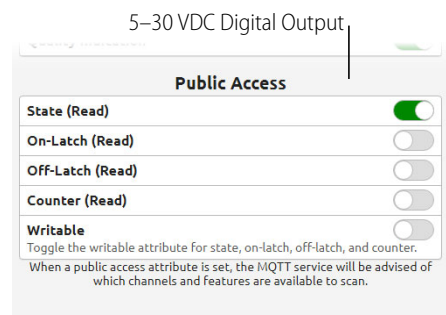

5-30 VDC Digital Output

- f. Review the rest of the fields on the channel page and make changes based on the needs of your application. For example, you may want to set a Watchdog timer on a channel or set the scaling values for a temperature probe.
- g. Click Save. *groov* Manage displays the channel page with information based on your selected channel type. For the same examples shows in [step d](#), this is what the channel page may look like:

Note that the above image shows channel 6 configured to sense from an ICTD temperature probe. However, an actual probe has not been wired to channel 6 on this RIO, which means that RIO is sensing values that are out of range from this configuration. RIO reports this as a quality error.

When you are done configuring all your channels, *groov* Manage displays your selections on the I/O Channels page.

If you haven't already done so, wire your field devices to your RIO as described in ["Connecting Field Devices"](#) on page 11.

CONFIGURING I/O THROUGH CODESYS DEVELOPMENT SYSTEM

After you add the Opto 22 Library Package for CODESYS Development System, you can add *groov* RIO (and *groov* EPIC) devices to your CODESYS projects. In CODESYS, a *groov* RIO is an Ethernet device, and each channel is a device you "plug" into that Ethernet device. To select the signal types and features for each channel, you configure the parameters of the device you "plugged in". To differentiate between the *groov* RIO "device" and the channel "device", we will include "(*groov* RIO)" or "(channel)" after each reference to "device", as necessary. You may also want to read the note below for more clarification on terminology differences.

Here's what you need to do to configure I/O through CODESYS Development System:

1. Verify that you have the correct version of the Opto 22 Library Package, CODESYS Development System, and *groov* RIO firmware. For guidance on what to check, see ["Checking Compatibility Between Library Package, Development System, and Firmware"](#) on page 64.
2. Add the RIO to your CODESYS project.
3. Add channels by "plugging in" devices.

4. Select the signal types and configure the features for each channel by editing the “plugged in” device’s parameters.

Note: Throughout this section, instructions may use CODESYS terminology that differs from standard Opto 22 terminology. For example:

- In the CODESYS Development System interface, the term “device” refers to many different objects: a controller, an Ethernet adapter, a field device, or an I/O module. In this guide, “device” typically refers to a field device (a valve, a pump, a quadrature encoder, etc.). When you read sections of the guide that do not discuss CODESYS, you can interpret references to “device” to mean the latter definition.
- In CODESYS terminology, a groov EPIC processor, a groov RIO, and channels on a groov RIO are referred to as devices; throughout other sections of this guide, a groov EPIC processor is referred to as a processor, a groov RIO is referred to as a RIO module, and a channel is referred to as a channel.
- An application, in CODESYS terminology, is roughly equivalent to a PAC control strategy in Opto 22 terminology.

Checking Compatibility Between Library Package, Development System, and Firmware

The CODESYS Development System offers a rich and broad range of support for devices. As with any robust development system, it’s important to keep up-to-date with releases and review the features, enhancements, and fixes included in each release, as well as diligently check for compatibility with related software and firmware. In the CODESYS development environment, it’s important to check compatibility between three main pieces:

- **Opto 22 Library Package for CODESYS Development System.** The package contains information for CODESYS Development System so that it can configure *groov* EPIC processors, *groov* I/O modules, and *groov* RIO modules. Opto 22 updates the package each time a new module is introduced, as well as to deliver , and bug fixes. You want to review the readme to learn:
 - Which version of the package delivered support for the *groov* I/O or RIO module you want to use in your application.
 - The features, enhancements, or bug fixes delivered in each version of the package.
 - The pre- or co-requisites (for example, a new version of firmware for a *groov* I/O or RIO module) that might be required by one of these features, enhancements, or bug fixes.
 - Whether the package requires an updated version of the CODESYS Development System.
 You should periodically check the Opto 22 website for updates to the package. For instructions on installing the latest version of the package into CODESYS Development System, see [“Updating Device Information with the Latest Version of Opto 22 Library Package” on page 64](#).
- **CODESYS Development System.** The Development System periodically releases features, enhancements, and bug fixes that may affect how it works with library packages and with device firmware. It’s important to check that you are running with a version of CODESYS Development System that is compatible with the Opto 22 Library Package. To check the version number, see the CODESYS online help.
- **groov RIO Firmware.** Opto 22 updates the firmware to add enhancements and features or to fix bugs. Make sure to check the Readme file to learn whether it’s compatible with the version of the Opto 22 Library Package installed in your CODESYS Development System. If you need to update RIO firmware, see [“Updating Firmware on a groov RIO” on page 96](#).

Updating Device Information with the Latest Version of Opto 22 Library Package

If this is the first time you are adding a *groov* RIO device to your project, you only have to do steps [1](#), [2](#), [10](#), and [11](#). If you are updating existing RIO devices in your projects, do all of the steps.

1. Download and install the latest version of the library package from our website.
 - a. Go to the Opto 22 website, www.opto22.com.
 - b. Enter “Opto 22 Library Package” in the search box to find the page “Opto 22 Library Package for CODESYS Development System” and click the link.
 - c. Click Download and save the package to the same computer where you installed CODESYS Development System.
 - d. Open CODESYS Development System and install the package. For instructions on how to do this, see [Installing/Uninstalling a Package](#) in the CODESYS Online Help.
2. Review the readme for the Opto 22 Library Package for CODESYS Development System. Pay particular attention to the following:
 - If the package requires a newer version of CODESYS Development System than your current version, install the new version before proceeding further.
 - Make note of any additional tasks you may have to do after updating device information; for example, installing a new version of RIO module firmware.

Remember: If you are adding a groov RIO device for the first time, you can skip down to step 10.

3. Open your CODESYS project and, in the Device tree, expand the RIO device to see all the channels.
4. Right-click the RIO device and select Update Device.

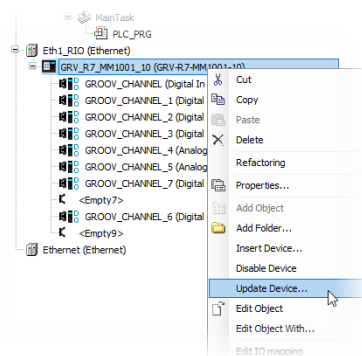

5. If the Update Device window does not automatically select the correct RIO device, navigate through the window to find it and select it.
6. Click Update Device.

CODESYS Development installs the new information about the RIO device. Now you need to update device information for each channel:

7. Right-click on a configured channel on the RIO device and click Update Device.

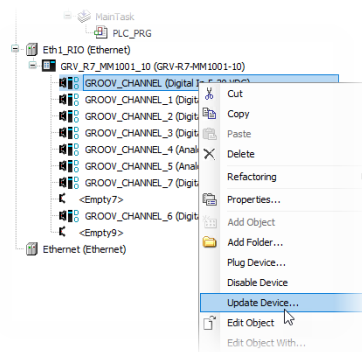

8. In the Update Device window, select the same device type (if it's not already selected). If applicable, choose the highest version number. Click Update Device.
9. Repeat [step 7](#) and [step 8](#) for each channel on the RIO.
10. Save your project.
11. If you noted any additional tasks in [step 2](#), make those changes now. Then, rebuild your project, test the changes, and verify that your application works as expected.

Adding a *groov* RIO to a CODESYS Project

Before you begin, verify that the PLC and the RIO are on the same network.

1. Open CODESYS Development System.
2. Open your project. (Click File > Open Project. Navigate to the folder where you stored the project file, select the project file, and then click Open.)
3. Add an Ethernet adapter to your PLC. With this adapter, you will identify which port on the RIO communicates to the PLC.
 - a. Right-click on your PLC.
 - b. Click Add Device.
 - c. Under Fieldbusses, expand Ethernet Adapter, then click Ethernet.
 - d. Click Add Device.
 - e. Click Close.
 - f. Double-click the Ethernet adapter to open the Ethernet Adapter's object view.
 - g. Click the More button () next to the Interface field.

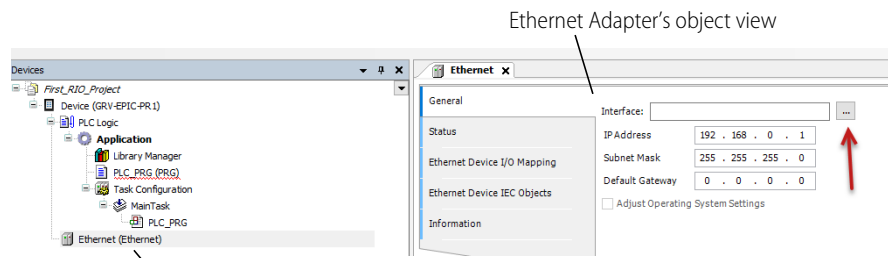

The Ethernet Adapter added in steps [a](#) through [e](#).

- h. Select eth0 or eth1, whichever port is connected to the network.
 - i. Click OK.
4. Add the RIO to the Ethernet adapter:
 - a. Right-click on the Ethernet adapter you just added.
 - b. Click Add Device.
 - c. Expand Miscellaneous and select a RIO by its part number. For example, GRV-R7-MM1001-10.
 - d. Click Add Device.
 - e. Click Close.
5. Assign the RIO's IP address to the address parameter of the device.
 - a. Double-click the RIO device you just added. CODESYS Development System opens the object view. If the Parameters tab is not selected, then select it.

- b. Click on the Value column for the Address parameter. Enter either the hostname or the IP address of the RIO, surrounded by single quotes.

Object view of the RIO device added in step 4.

Value column of Address parameter.

Parameter	Type	Value	Default Val...	Unit	Description
Address	STRING(255)	'opto-00-00...	'opto-00-00...		IP Address or hostname of the I/O unit. Use '127.0.0.1' for local I/O.
Port	UINT	2001	2001		OptoMMP Port
Communication Timeout (ms)	DWORD	1000	1000		Maximum time for the I/O unit to respond in milliseconds
Watchdog Timeout (ms)	DWORD	0	0		I/O Unit communication watchdog timeout (0 is off, non-0 is timeout in ms)
Temperature Units	Enumeration of DWORD	Degrees Ce...	Degrees Ce...		Temperatures can be read in degrees Celsius or degrees Fahrenheit.
Enable Configuration	BOOL	TRUE	TRUE		FALSE also disables configuration for all child modules.
Streaming Interval (ms)	DWORD	20	20		Rate at which input data will be published by the I/O. NOTE: It is highly advisable to u
Debug Level	Enumeration of DWORD	None	None		Controls the amount of debugging information logged as INFO messages.
Auto-Reconnect	BOOL	TRUE	TRUE		Automatically attempt to reconnect after a communication failure.

The RIO device added in step 4.

6. Save your project.

Adding Channels and Selecting Signal Types (Plugging in Devices)

To configure a channel, you “plug in” a device to your RIO. Now is when you need the information you collected when you reviewed “[Selecting Functions, Signals, and Features](#)” on page 59.

1. Right-click on a channel (empty slot) and select Plug Device.

Remember to pay careful attention to the channel you select; remember that not all channels support all functions, signal types, or features.

2. In the Plug Device window, expand Miscellaneous, then select which signal you want to assign to that channel (device).
3. Click Plug Device.

You can continue adding/configuring channels by clicking on another channel, selecting a signal type in the Plug Device window, then clicking Plug Device.

4. Click Close when you are done.

Changing Signal Types (Updating Devices)

If you want to change signal type you assigned to a particular channel (device):

1. Right-click on the channel and select Update Device.
2. In the Update Device window, expand Miscellaneous, then select the new signal you want to assign to that channel (device).
3. Click Update Device.

You can continue changing signal types by clicking on another channel (device), selecting a new signal type in the Update Device window, then clicking Update Device.

4. Click Close.

Setting Features (Configuring Object Parameters)

In CODESYS Development System, a *groov* RIO feature is identified as an object’s parameter. For example, an analog ICTD Temperature signal has several features, which are listed in the table on [page 68](#). In CODESYS Development System, you would see these features listed as parameters in the Parameters tab of the object view.

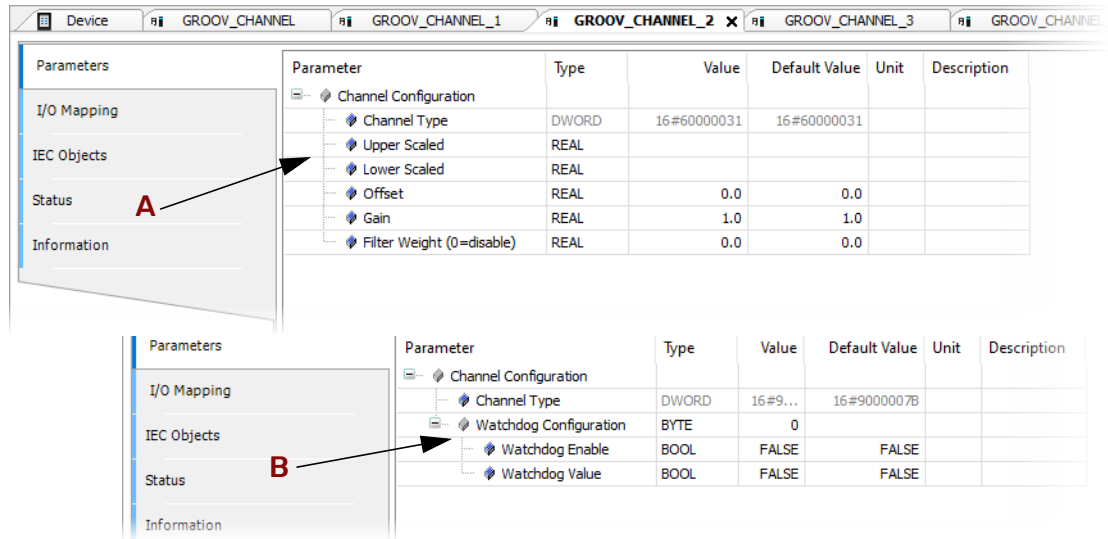

- A** Features for an ICTD signal on a channel of a GRV-R7-MM1001-10. Compare the parameters list with the list of features on the table for an analog input ICTD signal. All but two features are available on CODESYS.
- B** Features for a digital output signal on channel 0 of a GRV-R7-MM1001-10. Compare the parameters list with the list of features on the table for a digital output DC sinking signal. Only one feature is available on CODESYS: Watchdog Timeout Value.

The following table lists the features for the functions and signal types that you can select and configure on a GRV-R7-MM1001-10.

Function	Signal Types	Features
Input Channels	Digital	<ul style="list-style-type: none"> • Digital • Switch Input, powered <p>Channels 0-7:</p> <ul style="list-style-type: none"> • On/Off State <p>Channels 0 & 1:</p> <ul style="list-style-type: none"> • Counting
	Analog	<ul style="list-style-type: none"> • Voltage • Current • ICTD • Thermocouple • Millivolt <ul style="list-style-type: none"> • Scaling • Offset and Gain • Average Filter Weight
Output Channels	Digital	<ul style="list-style-type: none"> • DC Sinking <ul style="list-style-type: none"> • On/Off State • Watchdog Timeout Value
	Analog	<ul style="list-style-type: none"> • Current • Voltage <ul style="list-style-type: none"> • Scaling • Clamping • Watchdog Timeout Value
	Mechanical Relay	<ul style="list-style-type: none"> • Form C-NO • Form C-NC <ul style="list-style-type: none"> • On/Off State • Watchdog Timeout Value

For a list of the signal types and features for all RIO models, see [Appendix A: Specifications](#). If a feature listed in that appendix is not listed in the Parameters tab of the object view, the feature is not configurable through CODESYS Development System.

Configuring Channel Features (Device Parameters)

1. If you haven't started CODESYS Development System, start it and open your project.
2. Open or select the Devices view, then expand the Ethernet branch of your *groov* RIO.

3. Double-click the device (channel) you want to configure. CODESYS Development System opens the object view for that device. Check that the Parameters tab is selected.
4. Find the parameter (feature) you want to configure:
 - **For devices (channels) with scaling:** If you want to set scaling values, first determine the upper and lower ends of the scale. For example, if your input range is ± 150 mV and it is connected to a tank that can hold 1000 liters, you can set the lower end of the scale (-150 mV) to represent 0 liters and the upper end of the scale ($+150$ mV) to represent 1000 liters. With a signal type of Analog In ± 150 mv (for example, on a GRV-R7-MM1001-10):
 - On the Upper Scaled row, double-click the Value cell and enter 1000.
 - On the Lower Scaled row, double-click the Values cell and enter 0.
 To set default scaling, leave the Value cells blank or enter 0.
 - **For devices (channels) with clamping:** If you want to limit the output sent out from the device (channel), first determine the upper and lower end of that range. For example, suppose you want the output range to be 5–15 mA. On a signal type of Analog Out 0–20 mA (for example, on a GRV-R7-MM1001-10), to limit the range to 5–15 mA:
 - On the Upper Clamp row, double-click the Value cell and enter 15.
 - On the Lower Clamp row, double-click the Value cell and enter 5.
 To set no clamping, set both Values cells to 0.
 - **For devices (channels) with counting:** If you want to use the counting feature, you must select it. On the Feature row, double-click the Value cell to display the drop-down arrow.

Parameter	Type	Value	Default Value	Unit	De
Channel Configuration					
Channel Type	DWORD	16#50000068	16#50000068		
Feature	Enumera...	None	None		

Click the arrow to display a list, then select Counter.

Parameter	Type	Value	Default Value	Unit	Descri
Channel Configuration					
Channel Type	DWORD	16#50000068	16#50000068		
Feature	Enumera...	<div style="border: 1px solid black; background-color: #e0e0e0; padding: 2px;"> None </div> <div style="border: 1px solid black; background-color: #c0c0c0; padding: 2px; margin-top: 2px;"> Counter </div>	None		

5. Repeat [step 4](#) for each device (channel) you want to configure.

Remember to save your project periodically.

If you haven't already done so, wire your field devices to your RIO as described in "[Connecting Field Devices](#)" on [page 11](#).

UNDERSTANDING HOW QUALITY ERRORS ARE REPORTED

Some signal types on a *groov* RIO can report quality errors, which are common errors like input values that are out of range. *groov* Manage can show you that there is a quality error in the I/O Channels page by highlighting the channel yellow and showing brief message about the quality error.

Viewing Information About a Quality Error

1. Log into your *groov* RIO with a user ID that has administrator privileges.
2. Click I/O Channels. *groov* Manage displays the list of channels and highlights the channel that is reporting the quality error with a yellow background.

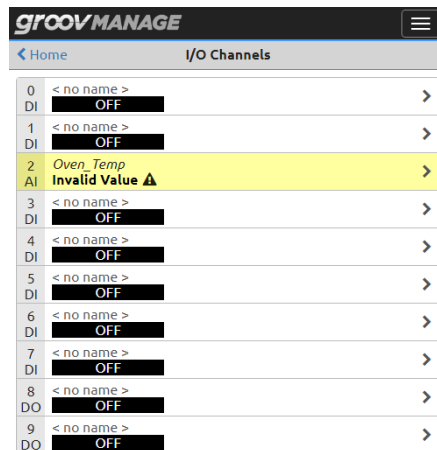

Click on that channel.

3. *groov* Manage displays the specific information about that channel:

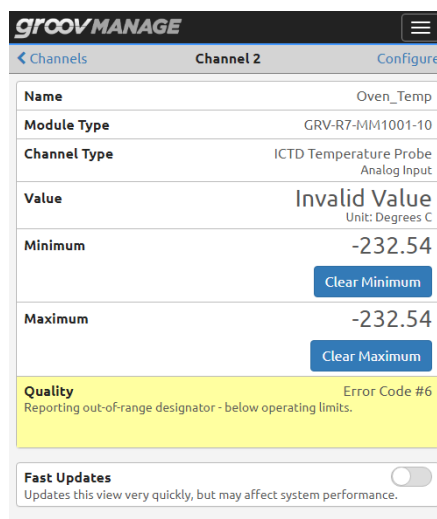

The Quality field shows you a message with an error code number and a possible reason for the error. This information can help you troubleshoot problems with a field device wired to that specific channel.

9: Enabling MQTT

WHAT IS MQTT?

MQTT is a publish/subscribe (pub/sub) protocol that's suited to many IIoT applications because of its architecture.

In a pub/sub architecture, a central source, called a broker, receives, distributes, and in some cases, retains data. MQTT clients can publish data to the broker or subscribe to get data from a broker (or both). Clients who publish data send it only when they choose to publish. Clients who subscribe to data automatically receive it from the broker only when the publishers sends data.

Contrast this with a client/server architecture. With this architecture, the client and server must be connected, because the client requests data directly from the server. The client doesn't know when the data changes, so it must request it at regular intervals.

MQTT pub/sub offers three main advantages over client/server for IoT applications:

- Network traffic is reduced overall because data is published and sent only when it changes, rather than at regular intervals.
- Because the broker is a central source that manages data, the broker can take over the data management workload typically handled by a server in a client/server model, and the server now handles fewer clients. And even remote devices with irregular connections or low bandwidth can publish or subscribe to data. If a publisher can't connect to the broker, for example, the publisher can optionally buffer its data and send it at a later time.
- For data publishers and subscribers, there's another important advantage: data is published and subscriptions are initiated through an outbound connection. Most firewalls block inbound connection requests (for example, an external OPC client requesting data from an internal OPC server), but they allow outbound connections over secure TCP ports. A device (in this case, RIO) initiates an outbound connection through a secure port, and the traffic travels both directions through that connection.

See mqtt.org for more information about the protocol.

MQTT on *groov* RIO

One of the features of MQTT is that the data (payload) it transmits can be in a format best suited for the application. *groov* RIO can transmit payloads formatted to meet the Sparkplug-B specification or formatted as strings. In addition, RIO offers several features and capabilities to suit a variety of application requirements.

Review the following list of features and capabilities and select the option that best suits your application:

- **MQTT with string payloads**—Select this option if:
 - Your application requires that the payload be formatted as a string.
 - Your application is simple, perhaps monitoring or controlling only a few devices.

CONFIGURING AND ENABLING MQTT WITH STRING PAYLOADS

- Your application requires automation data from *groov* RIO, but not from other PLCs.
- You are looking for a cost-effective option. This option does not require the purchase of additional licenses.

With this option, you will need to:

- Convert data within your application. With payloads formatted as strings, you will need to add logic to your application to convert strings to the correct data type, when necessary.
- Define the topic namespace.
- **MQTT with Sparkplug payloads published from *groov* RIO**—Select this option if:
 - Your application requires that the payload be formatted to comply with the Sparkplug specification.
 - Your application requires automation data from *groov* RIO, but not from other PLCs.
 - You are looking for a cost-effective option. This option does not require the purchase of additional licenses.

With this option, you'll be able to queue data into RAM if network connectivity is lost, which will then be transmitted when the service is available. However, because the queued data is stored in RAM, it can be lost when power is cycled or space runs out.

Keep in mind that you will need to:

- Define the topic namespace.
- Provide the MQTT configuration information through *groov* Manage and then enable the service.

Note that you cannot combine these two options; you must choose one or the other.

- For MQTT with string payloads, see [“Configuring and Enabling MQTT with String Payloads” on page 72](#).
- For MQTT with Sparkplug payloads published from *groov* RIO, see [“Configuring and Enabling MQTT with Sparkplug Payloads from *groov* RIO” on page 75](#).

CONFIGURING AND ENABLING MQTT WITH STRING PAYLOADS

To connect your *groov* RIO to an MQTT infrastructure, you will need to:

- Create a new MQTT broker or establish access to an existing one. The broker can be located on your premises or in the cloud. You can search the Internet for information from various vendors about MQTT brokers; setting up an MQTT broker is not covered in this guide.
- Configure and start the MQTT service through *groov* Manage.

Before configuring, it's helpful to first collect information about the MQTT broker, determine some identifying information for RIO, and review settings that may affect transmission performance.

Collecting Information

Collecting information about the MQTT broker

You'll need the following information about the MQTT broker:

- **Broker URL**—The URL of the MQTT server
- **Client ID**—(Optional) Enter a client ID only if one was supplied. If you do not enter a client ID, the MQTT service will generate one.
- **Username**—The username you need to access the broker
- **Password**—(Optional) If required, the password you need to access the broker
- **SSL**—If your MQTT server requires SSL, you need to upload the correct SSL certificate to your *groov* RIO before you begin configuring the MQTT service. For instructions, see [“Managing the SSL Security Features of your *groov* RIO” on page 24](#).
- **Keep Alive (s)**—The number of seconds between heartbeats.

Specifying Default Topics for *groov* RIO

You'll need to collect or create the following information to uniquely identify your *groov* RIO in your MQTT infrastructure. If necessary, consult with someone who assigns topics to determine if RIO will be assigned a specific set of topics, and whether you should follow a particular naming convention. All of the following information is required:

- **MQTT Base Topic**—The base topic is prefixed to the MQTT topic used to publish data.
- **MQTT Group Topic**—Identifies the group that your *groov* RIO belongs to
- **MQTT Subgroup Topic**—Identifies a subdivision within the group

In addition, you'll need:

- **MQTT Device Topic**—Identifies your *groov* RIO within the subgroup
- **Use Comma in Floats**—If your application uses a comma to separate values (for example, pi is denoted as 3,14 instead of 3.14), you'll want to indicate that when you enter configuration information in *groov* Manage.

Reviewing *groov* RIO Performance Settings

You may want to review the following settings, which can affect throughput in an MQTT infrastructure. Changing the settings can help you fine-tune throughput:

- **CommTimeout (ms)**—The default connection timeout value is 5000 milliseconds. You can adjust this value to account for slower or faster infrastructures. (For example, if your *groov* RIO is in an area with "spotty" or slow connection, you may want to increase this value.) Minimum is 1000; maximum is 30,000.
- **Scan Time (ms)**—The scan interval in milliseconds. You may need to adjust this if the scans can't finish before the time is up.

Configuring and Enabling MQTT Service

Make sure you are logged into your *groov* RIO with an ID with administrator privileges before starting:

1. From the *groov* Manage Home page, click MQTT, then Configuration.

The screenshot shows the 'GROOV MANAGE' interface for MQTT configuration. At the top, there are 'Cancel' and 'Save' buttons. The main section is titled 'Edge Node'. Below this, there are several configuration fields:

- MQTT Payload:** Set to 'MQTT with Sparkplug payloads'.
- Group ID:** Labeled 'The Sparkplug Group ID', marked as 'Required'.
- Edge Node ID:** Labeled 'The Sparkplug Edge Node ID', marked as 'Required'.
- Primary Host ID:** Labeled 'The Sparkplug Edge Node ID', marked as 'Optional'.
- Compression:** Set to 'none'.

At the bottom of the configuration area, there are three buttons: 'Add MQTT Broker', 'Add Device', and 'Delete Configuration'.

2. In the Edge Node section:

CONFIGURING AND ENABLING MQTT WITH STRING PAYLOADS

- a. Click MQTT Payload.

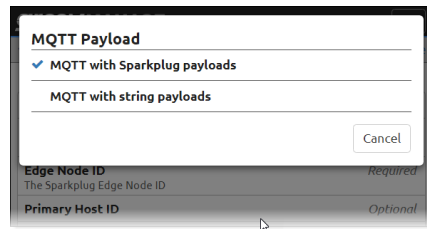

The image shows a dialog box titled "MQTT Payload". It contains two radio button options: "MQTT with Sparkplug payloads" (which is selected) and "MQTT with string payloads". Below these options is a "Cancel" button. At the bottom of the dialog, there are two fields: "Edge Node ID" (with the subtext "The Sparkplug Edge Node ID" and a "Required" label) and "Primary Host ID" (with an "Optional" label).

- b. Click MQTT with string payloads.

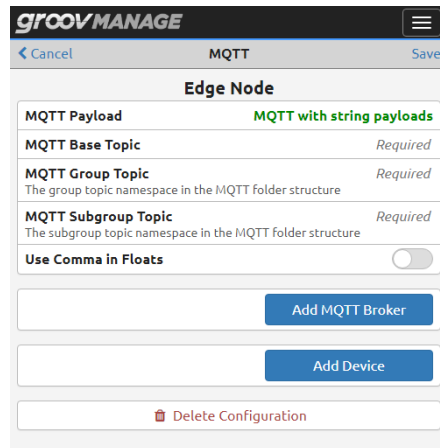

The image shows the "MQTT" configuration screen in the GroovManage application. The screen has a header with "groovMANAGE" and a menu icon. Below the header are "Cancel" and "Save" buttons. The main section is titled "Edge Node" and contains several fields: "MQTT Payload" (set to "MQTT with string payloads"), "MQTT Base Topic" (Required), "MQTT Group Topic" (Required, with subtext "The group topic namespace in the MQTT folder structure"), "MQTT Subgroup Topic" (Required, with subtext "The subgroup topic namespace in the MQTT folder structure"), and "Use Comma in Floats" (a toggle switch). At the bottom, there are three buttons: "Add MQTT Broker", "Add Device", and "Delete Configuration".

Enter the information you collected in "Specifying Default Topics for groov RIO" on page 73.

3. Click Add MQTT Broker.

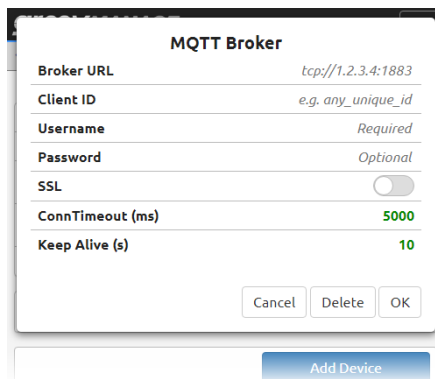

The image shows the "MQTT Broker" configuration dialog box. It contains several fields: "Broker URL" (with example "tcp://1.2.3.4:1883"), "Client ID" (with example "e.g. any_unique_id"), "Username" (Required), "Password" (Optional), "SSL" (toggle switch), "ConnTimeout (ms)" (5000), and "Keep Alive (s)" (10). At the bottom, there are three buttons: "Cancel", "Delete", and "OK". Below the dialog, there is an "Add Device" button.

Enter the information you collected in "Collecting information about the MQTT broker" on page 72. Click OK to close the MQTT Broker window and return to the MQTT page.

4. Click Add Device.

Enter the information you collected in “Reviewing groov RIO Performance Settings” on page 73.

Note: Ignore the *Additional Host Tasks* field; RIO does not have host tasks.

5. Click Save. *groov* Manage validates the information you entered.

If it passes this validation, click Yes to confirm that you want to save these settings and start the MQTT service. This may take a minute. When it is done, *groov* Manage displays the MQTT page.

CONFIGURING AND ENABLING MQTT WITH SPARKPLUG PAYLOADS FROM *groov* RIO

To connect your *groov* RIO to an MQTT infrastructure, you will need to:

- Create a new MQTT broker or establish access to an existing one. The broker can be located on your premises or in the cloud. You can search the Internet for information from various vendors about MQTT brokers; setting up an MQTT broker is not covered in this guide.
- Configure and enable the MQTT service through *groov* Manage.

Before configuring, it’s helpful to first collect information about the MQTT broker, determine some identifying information for RIO, and review settings that may affect transmission performance.

Collecting Information

Collecting information about the MQTT broker

Collect the following information about the MQTT broker:

- **Broker URL**—The URL of the MQTT server
- **Client ID**—(Optional) Enter a client ID only if one was supplied.
- **Username**—The username you need to access the broker
- **Password**—(Optional) If required, the password you need to access the broker.

- **SSL**—If your MQTT server requires SSL, you need to upload the correct SSL certificate to your *groov* RIO before you begin configuring the MQTT service. For instructions, see [“Managing the SSL Security Features of your *groov* RIO” on page 24](#).
- **ConnTimeout (ms)**—The default connection timeout value is 5000 milliseconds. You can adjust this value to account for slower or faster infrastructures. (For example, if your *groov* RIO is in an area with “spotty” connection, you may want to increase this value.) Minimum is 1000; maximum is 30,000.
- **Keep Alive (s)**—The number of seconds between heartbeats. If there is no heartbeat for longer than the keep alive time, the last will and testament is sent.
- **Compression**—If you must compress the payloads before they are published to the MQTT server, determine if it uses gzip or deflate.

Specifying Unique Identifiers for *groov* RIO and Other Settings

You'll need to collect or create the following information to uniquely identify your *groov* RIO in your MQTT infrastructure. If necessary, consult with someone who assigns these IDs to determine if the processor will be assigned a specific set of IDs, and whether you should follow a particular naming convention.

- **Group ID**—Identifies the group that your *groov* RIO belongs to
- **Edge Node ID**—Identifies a subdivision within the group
- **Device ID**—Identifies your *groov* RIO within Edge node

You may also need the Primary Host ID, which enables notifications as to the “state” (offline or online) of the MQTT server.

Reviewing Performance Settings

You may want to review the following settings, which can affect throughput in an MQTT infrastructure. Changing the settings can help you fine-tune throughput:

- **CommTimeout (ms)**—The number of milliseconds that the MQTT service waits for RIO to respond to a request. If you set this value too small, you may see erratic communication timeouts.
- **Scan Time (ms)**—The scan interval in milliseconds. You may need to adjust this if the scans can't finish before the time is up.
- **Historic Queue**—The maximum number of Sparkplug publications that may be historically queued when the connection to the broker fails. The value may range from 0 to 65535. You may want to change this value after considering the following factors:
 - The publications are stored in RAM, so storage can be consumed quickly when you specify a large value. Also keep in mind these three factors that can influence how many Sparkplug publications are created: how many tags are scanned, the scan rate, and the rate of tag changes.
 - If the number of publications exceeds this value, the oldest entries are discarded to make room for newer entries.

Configuring and Enabling MQTT Service

Make sure you are logged into your *groov* RIO with an ID with administrator privileges before starting:

- 1. From the *groov* Manage Home page, click MQTT, then Configuration.

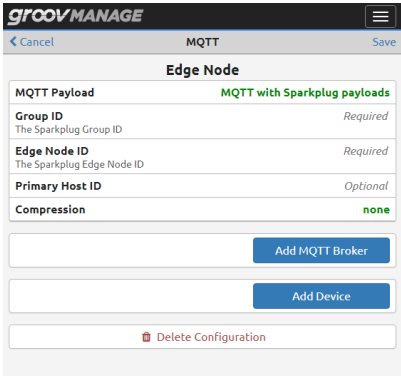

If MQTT with Sparkplug payloads is not listed in the MQTT Payload field, click on the field and select it from the MQTT Payload window.

- 2. In the Edge Node section, enter the information you collected in “Specifying Unique Identifiers for groov RIO and Other Settings” on page 76.

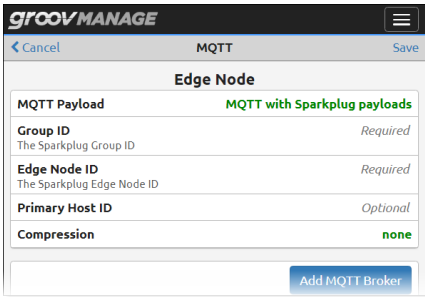

- 3. Click Add MQTT Broker. In the MQTT Broker page, enter the information you collected in “Collecting information about the MQTT broker” on page 75.

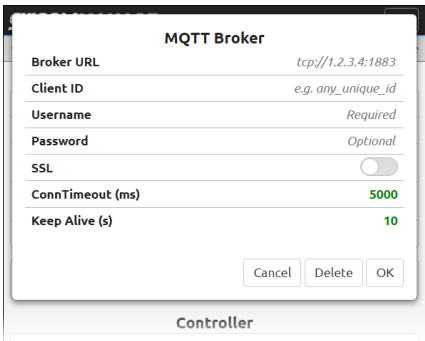

Click OK.

4. Click Add Device.

Device	
Device ID	<i>e.g. any_unique_id</i>
The Sparkplug Device ID	
CommTimeout(ms)	5000
Scan Time (ms)	1000
Additional Host Tasks	Optional
Historic Queue	Optional

Cancel Delete OK

Add MQTT Broker

Enter the information you collected in “Reviewing Performance Settings” on page 76.

Note: Ignore the Additional Host Tasks field; RIO does not have host tasks.

5. Click Save. Confirm that you want to save these settings and start the MQTT with Sparkplug service. This may take a minute. When it is done, groov Manage displays the MQTT page.
6. Enable the service by clicking Enable in the MQTT Status section.

10: Developing Node-RED Flows

If you are new to Node-RED, it might be helpful to review our Automation 101 video introducing Node-RED: [Intro to Node-RED: Part 1 - Fundamentals](#). (You can find other videos in the Support > Videos section of our website, www.opto22.com.) The “[Learning to Develop a Node-RED Flow](#)” section (below) will take you through a hands-on approach to learning how to develop a Node-RED flow. However, before you can begin those exercises or do anything else with Node-RED on your *groov* RIO, make sure you:

- Enabled Node-RED as described in “[Enabling Node-RED](#)” on page 56.
- Configured the channels on your RIO by one of the following methods:
 - As described in [Chapter 8: Configuring I/O](#).
 - Configured through a PAC Control strategy.
 - Configured through a custom control program.

FOR EXPERIENCED Node-RED DEVELOPERS

If you have experience developing Node-RED flow and just want to know which node to install to access I/O on your *groov* RIO, it is **node-red-contrib-groov-io**. This node can also access I/O on *groov* I/O modules mounted on an EPIC chassis.

You might also find the following nodes helpful:

- **node-red-contrib-groov**. Nodes to access a Data Store in a *groov* View project.
- **node-red-contrib-pac**. Nodes to access tags and strategy information from a PAC Control strategy running on a *groov* EPIC processor or SNAP PAC controller.

These are the URLs to access the Node-RED Editor in *groov* RIO:

- `https://[your groov RIO's hostname]/node-red`
- `https://[your groov RIO's IP address]/node-red`

LEARNING ABOUT Node-RED ON RIO

Opto 22 provides Node-RED nodes to access *groov* RIO I/O; the same nodes can also access I/O on a *groov* EPIC processor. Opto 22 also provides Node-RED nodes to access data in *groov* View Data Stores, as well as nodes to access strategy information from PAC Control strategies running on *groov* EPIC processors or SNAP PAC controllers. For more information on nodes, see developer.opto22.com.

Node-RED Editor. You can include one or many flows in your Node-RED project, which you build in the standard, browser-based Node-RED Editor. You can access the editor directly through a URL or navigate to it through *groov* Manage.

Debugging. With few programming restraints, it's easy to accidentally introduce bugs into your flow. The Node-RED Editor can help you debug flows. If Node-RED crashes, it automatically restarts. You can also start and stop Node-RED yourself from within *groov* Manage.

Files. Your Node-RED project consists of two files: the main file with all your flows, and a separate file containing all the sensitive credential information used by some nodes, such as usernames and passwords for an email node. *groov* RIO provides ways to backup and restore Node-RED projects, either separately or as part of the complete backup and restore.

LEARNING TO DEVELOP A Node-RED FLOW

If you are new to Node-RED, this section takes you step-by-step through the following exercises:

- Learning the different ways to open the Node-RED Editor in *groov* RIO.
- Creating a basic flow to display a timestamp; deploying the flow, operating a node, and observing its behavior; then enhancing the flow to modify the format of the timestamp.
- Adding nodes that can collect data from your RIO, a *groov* View Data Store, and a PAC Control strategy.
- Creating and deploying a flow that accesses tag values from a fictional PAC Control strategy.

Before you start these exercises, make sure you enable Node-RED (see “Enabling Node-RED” on page 56) and that your *groov* RIO has access to the Internet.

Opening the Node-RED Editor

You can open the Node-RED editor with either of the following methods:

- Open a web browser and enter either of the following in the URL bar:
 - `https://[your groov RIO's hostname]/node-red`
 - `https://[your groov RIO's IP address]/node-red`Don't forget the “s” in **https**. Examples:
 - `https://opto-00-d2-da/node-red`
 - `https://192.0.2.20/node-red`
- If you are in *groov* Manage, click the menu button () , then select Home. From the Home page, click on Node-RED, then Open Node-RED Editor.

If you are new to the Node-RED Editor, take a moment to review the following diagram to familiarize yourself with the different parts of the editor.

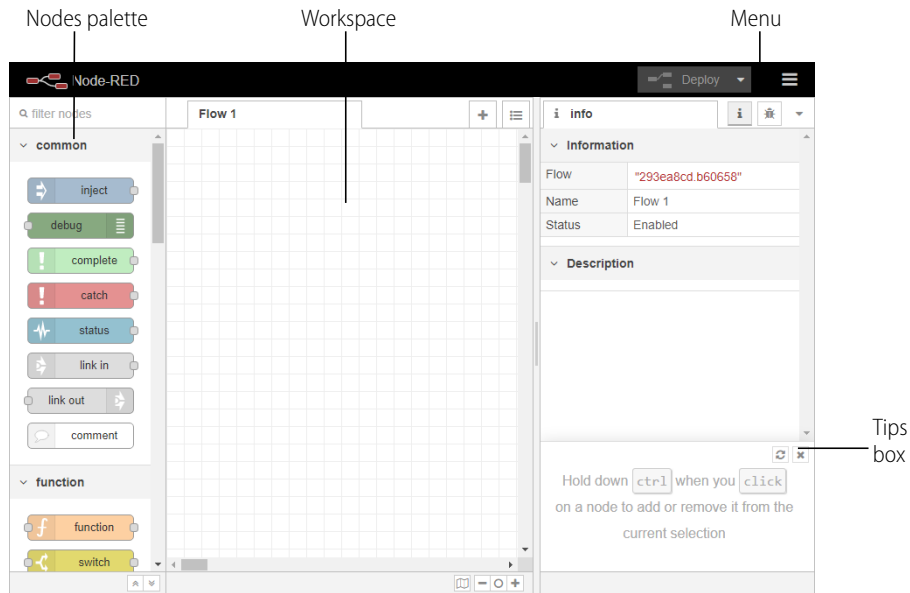

Creating a Flow

1. In the Nodes palette on the left, locate the *inject* node. Click and hold on it, then drag it to the workspace. The inject node lets you inject messages into a flow, either by clicking the button on the node or by setting a time interval between injects. The **info** tab on the right side-bar displays information about the inject node's properties and a description of what it does:

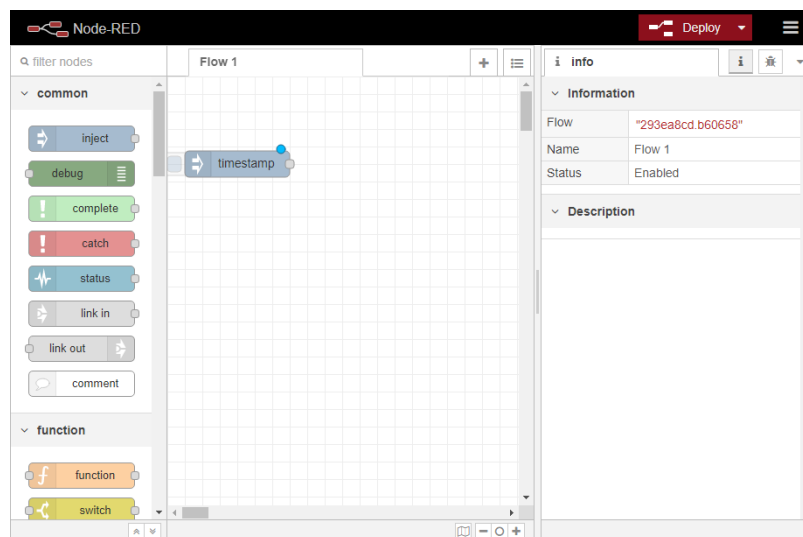

- You might want to close the Tips box so that you can see more information in the **info** tab.
2. Scroll down in the Nodes palette and locate the *debug* node. Drag it to the workspace.

3. Wire the inject and debug nodes together by dragging from the output port of inject to the input port of debug.

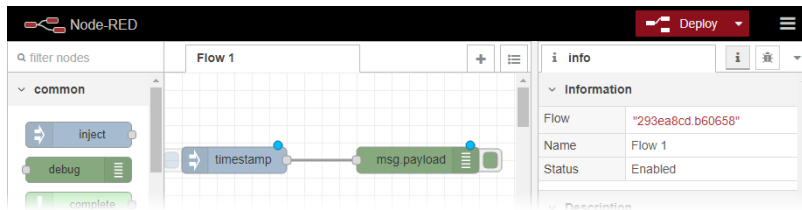

Deploying the Flow and Testing It

The nodes exist only in the editor and must be deployed to the server.

1. Click the Deploy button in the upper right.
2. In the right-sidebar, select the **debug** tab. (If you can't see the debug tab, click .)
3. Click the button on the left side of the inject node.
Numbers appear in the sidebar:

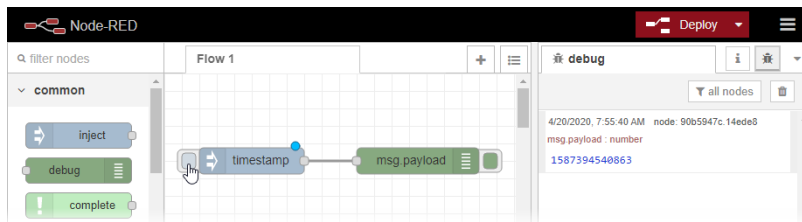

This number is a timestamp representing the number of milliseconds since January 1, 1970. This is the default payload of the Inject node.

Adding a Function Node

Let's make the timestamp more readable by using a Function node. Function nodes let you pass each message through a JavaScript function. If you don't know JavaScript, you may be able to find code you need using an Internet search.

1. Find the function node in the Nodes palette.
2. Click and hold on the function node, then drag it to the workspace, placing it between the inject and debug nodes. When the wire between the inject node and debug node becomes a dashed line, let go of the mouse button. The Node-RED editor automatically wires the Function node to the inject node and the debug (msg.payload) node.

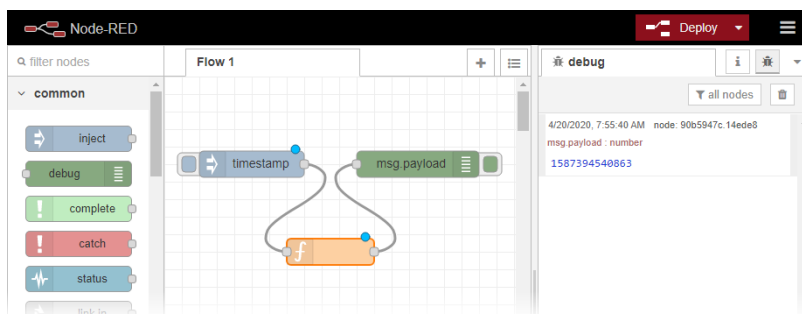

If you didn't see a dashed line:

- a. Drop the function node near the inject and debug node.
 - b. Delete the existing wire by selecting it and pressing Delete on the keyboard.
 - c. Add a wire to link the output of the inject node to the input of the function node.
 - d. Add a wire to link the output of the function node to the input of the debug (msg.payload) node.
3. Double-click the Function node to edit it. The Node-RED editor displays the Edit function node panel.

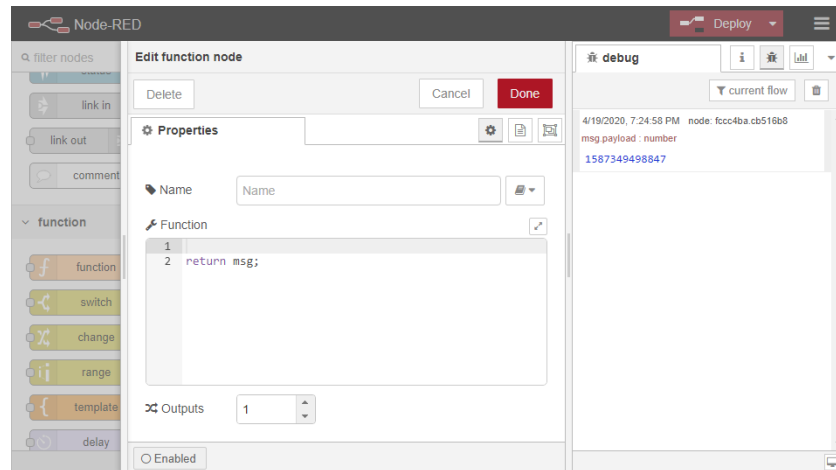

4. In the Name field, type `Human Date`.
5. Copy the following code into the Function field, at line 1:

```
// Create a Date object from the payload
var date = new Date(msg.payload);
// Change the payload to be a formatted Date string
msg.payload = date.toString();
```
6. Leave this code in place at the end:

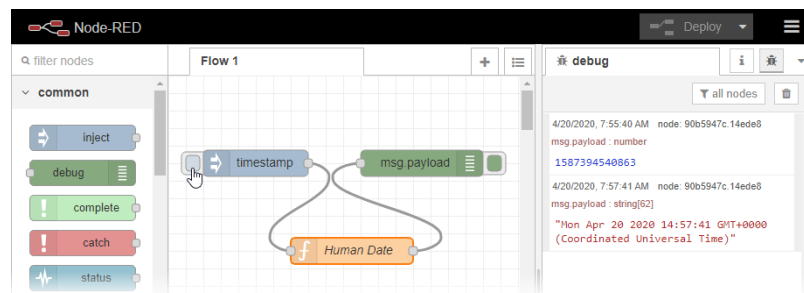

```
return msg;
```
7. Click Done to close the edit dialog box and then click the Deploy button.
8. Now when you click the Inject button, the message in the sidebar shows a more readable time stamp:



Installing *groov* I/O Nodes

groov I/O nodes can read and write data from your RIO or from I/O modules on an EPIC.

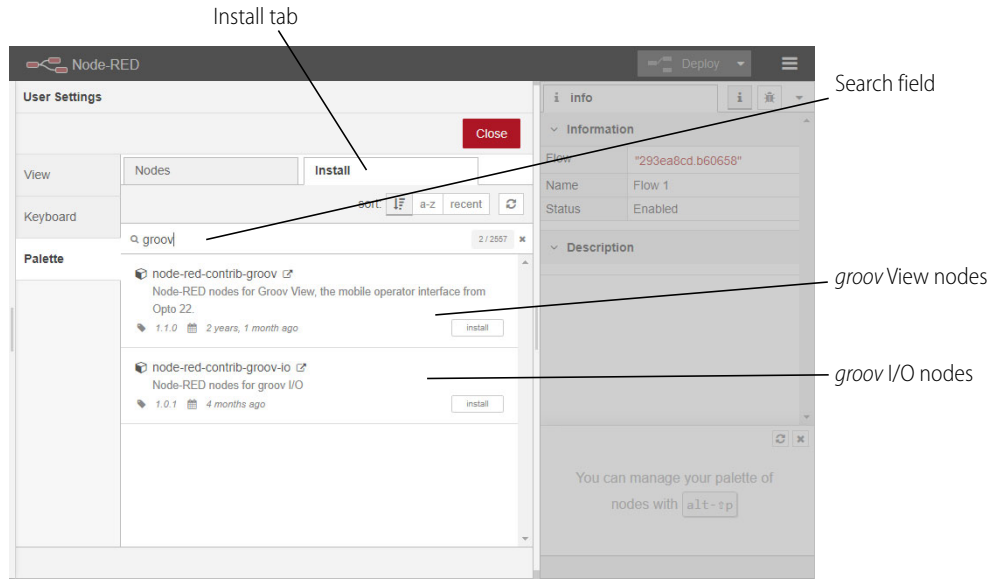
1. Click the menu button (☰), then select Manage palette.
2. Click the Install tab.
3. In the search field, enter `groov`.



4. Find `node-red-contrib-groov-io` in the list and click the Install button next to it.
5. The Node-RED Editor displays a message about checking dependencies and reviewing node documentation. Click Install. When installation is finished, the small Install button changes color to gray and changes text to Installed.

While you are here, you can also install the groov View nodes. This will help you save some steps in the next section, "Installing groov View Nodes to Access Data Stores" on page 85. The following image shows both nodes installed.

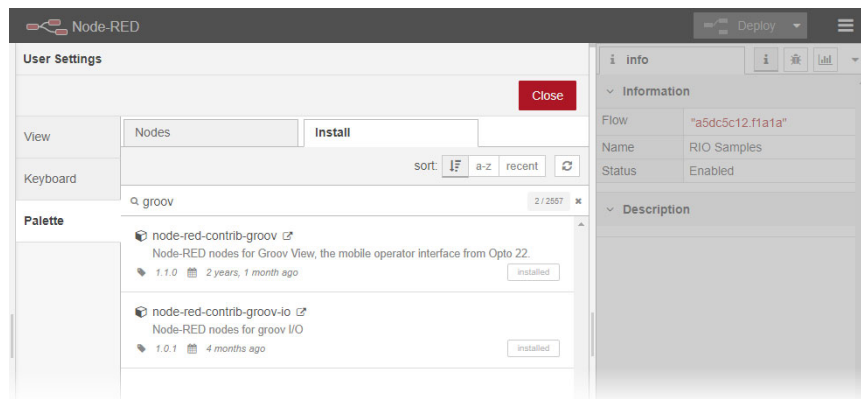

6. Click Close.

The new *groov* I/O and *groov* View nodes appear in the nodes palette, under the heading Opto22.

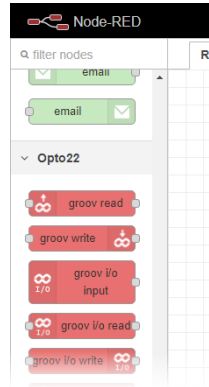

Installing *groov* View Nodes to Access Data Stores

groov View nodes can read and write data from a *groov* View Data Store. For an introduction to Data Stores and how to create them in *groov* View, see “Adding a Data Store” in the *groov* View *User’s Guide* (form 2027). After you create the Data Store in *groov* View, you can access the Data Store in your Node-RED flow by accessing the *groov* View project that contains the Data Store.

If you already installed the node-red-contrib-groov nodes to the Node palette when you went through “Installing groov I/O Nodes” on page 83, you can skip to the next section.

1. Click the menu button (☰), then select Manage palette.
2. Click the Install tab.
3. In the search field, enter `groov`.

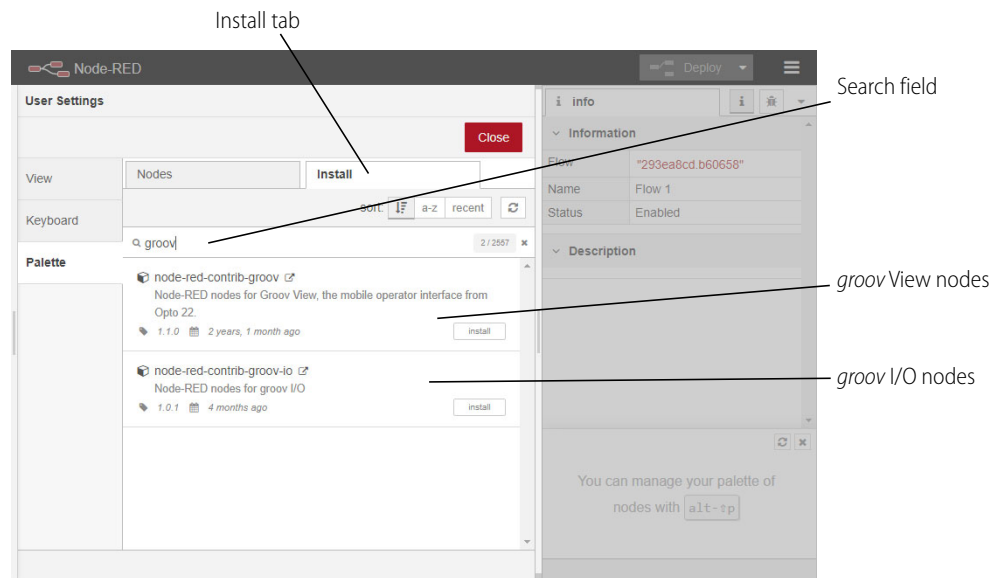

4. Find `node-red-contrib-groov` in the list and click the Install button next to it.

The Node-RED Editor displays a message about checking dependencies and reviewing node documentation. Click Install. When installation is finished, the small Install button changes color to gray and changes text to Installed.

The following image shows both groov I/O and groov View nodes installed.

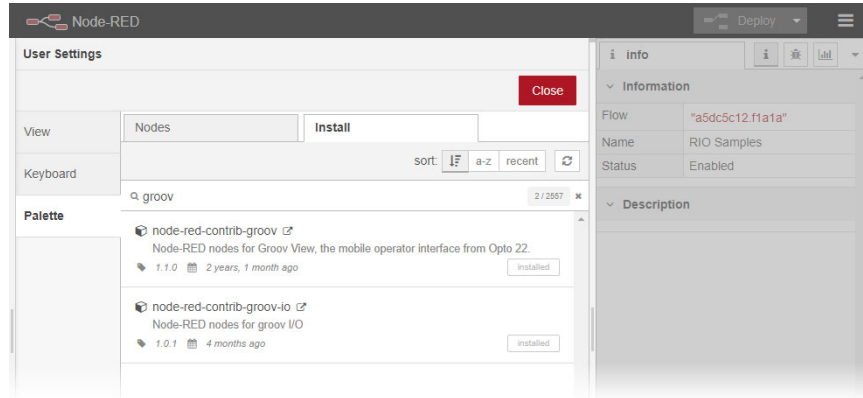

5. Click Close.

The new *groov* I/O and *groov* View nodes appear in the nodes palette, under the heading Opto22.

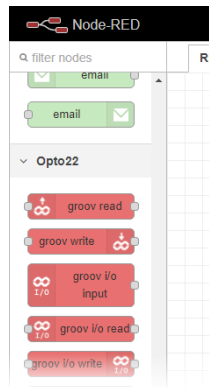

Installing Opto 22 PAC Control Nodes

For this section, you'll add nodes to establish real-world communication with *groov* View Data Stores and tags in PAC Control strategies. You need either of the following:

- An Opto 22 *groov* EPIC processor running a PAC Control strategy, or
- a [SNAP PAC S-series or R-series industrial controller](#) with firmware R9.5 or higher, running a PAC Control R9.5 or higher strategy.

For either of these options, you need to complete the configuration instructions on developer.opto22.com. At the website, click on Node-RED for PAC Control, then expand Getting Started.

- For the *groov* EPIC processor, click on *groov* EPIC Controller Configuration.
- For the SNAP PAC controller, click SNAP PAC Controller Configuration.

As you complete the processor or controller configuration, make sure to save the following information:

- API Key Name and Value (for SNAP PAC)
- API Key (for *groov* EPIC)
- Path and file name to the SSL Certificate

After you set everything up and gathered this information, you can start:

1. Install Node-RED for PAC Control nodes just as you installed the *groov* View nodes. (Menu > Manage palette > Install tab. Search for `node-red-contrib-pac`.)
2. Make sure you have an inject and a debug node in the workspace.

3. Near the bottom of the Nodes palette, click and hold on the pac read node and drag it to the workspace, in between inject and debug (msg.payload).
The pac read node lets you read I/O and variable data in the PAC Control strategy.
4. Wire the pac node to the inject node and debug node, in the same way you wired the Function node.
5. Click the node and click the **info** tab to see helpful information about the node.
6. Double-click the pac read node to edit it.

7. Click the pencil at the right of the Controller field.

8. Complete the fields:
 - a. For Address, choose a protocol and enter the IP address of the *groov* EPIC processor or the SNAP PAC controller.
 - b. For the API Key Name and API Key Value fields:
 - If you are accessing tags from a PAC Control strategy running on a SNAP PAC Controller, enter the API Key Name and Value you obtained when you configured the controller (as described on the previous page).
 - If you are accessing tags from a PAC Control strategy running on a *groov* EPIC processor, enter the API Key into the API Key Value field. Leave the API Key Name field blank.
 - c. For the SSL Certificates (PEM format) fields:
 - If you selected HTTPS as the protocol, read the information in the **info** tab to determine what to enter in these fields.
 - If you selected any other protocol, you can leave these fields blank.
 - d. Click Add.

The Node-RED editor returns you to the Edit pac read node panel, where your node is now configured to access the I/O and variable data in the PAC Control strategy running on the *groov* EPIC processor or the SNAP PAC controller:

Edit pac read node

Delete Cancel Done

node properties

Device 192.0.2.20

Data Type Digital Input

Tag Name Leave blank to get all tags

Value msg.payload

Topic Do not alter

Node Name Name

9. Choose the Data Type from the dropdown list. The data type determines what other fields appear. In this example we chose Analog Input, so a field appears for Tag Name.

Edit pac read node

Delete Cancel Done

node properties

Device 192.0.2.20

Data Type Analog Input

Tag Name aiOvenTemperature

Value msg.payload

Topic Do not alter

Node Name Name

- a. **Tag Name**—Enter the exact I/O point or variable name from the PAC Control strategy running on this controller. If you leave this field blank, you'll receive values for all tags of this type (in this example, all analog inputs).
 - b. **Start Index** and **Length**—For a table, enter the starting index and length of the data you want to use.
 - c. **Node Name**—(Optional) By default, the tag name is used for this node. If you want to give it a different name, enter it here.
 - d. Click Done.
10. Click the down arrow next to Deploy to see your choices.

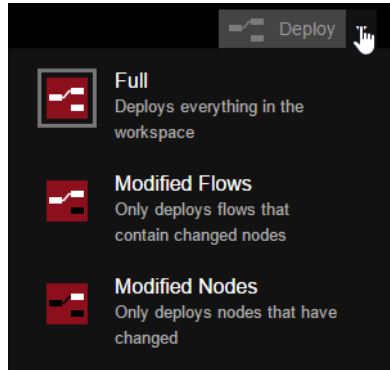

You can deploy everything, or if you don't want to disturb running flows, you can choose to deploy only the changed flows or changed nodes.

The gray box around the icon shows what will happen when you click the Deploy button. In this example, everything is deployed (Full).

11. Click Deploy. Now click the inject button and see what message appears in the debug tab. You should see the data from your PAC Control strategy. Here's how our example looks:

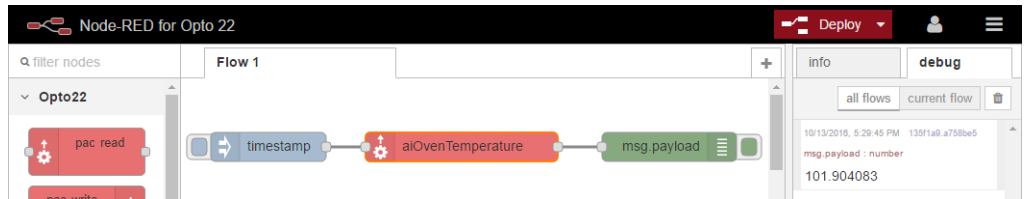

11: Maintaining a *groov* RIO

You'll want to maintain your *groov* RIO units regularly to keep them up-to-date, running smoothly, and to make it easier to restore in the event of a reset:

- Back up your information regularly
- Apply firmware updates

If you encounter problems while operating your *groov* RIO unit, here are a few things you can do:

- You can troubleshoot some problems and, if you can't resolve your problems, there are some steps you can take to help Product Support solve your problems.
- If you had to restore your processor to factory defaults, you can restore the information that you backed up.

BACKING UP YOUR *groov* RIO SETTINGS

Recommendations vary regarding when and how often you should back up your *groov* RIO:

- Before you apply a firmware update.
- Before you change configuration, like channel function.
- Periodically; for example, once a year.

Whichever recommendation you follow, the *groov* Manage Backup feature can save valuable configuration information, which you can then restore at a future date.



However, keep in mind the following:

- The backup feature saves only the first 10 MB of user files, which are files that either you uploaded manually to the processor or were placed there by control programs.
- While the backup feature does save your Node-RED projects (flows and credentials), it does not save any nodes you installed; for example, Opto 22 nodes or nodes to access cloud services.

IMPORTANT: *The backup file is not a secured or encrypted file. You must apply your own security or encryption to the file to protect any sensitive information. Also, be aware that if you send a backup file to Opto 22 without any security or encryption, our personnel will have access to all the information in that file.*

After you select a back up folder or medium, do the following steps:

1. On a computer or mobile device that is connected to the medium or folder where you want to save your back up file, log into your *groov* RIO with a user ID that has administrator privileges.
2. Click Maintenance > Backup.

3. On the Backup page, select the information you want to back up by moving the corresponding slider to the right so that it shows green (). By default, everything except Server SSL Certificates and network configurations are backed up. If you do not want certain information backed up, move the slider to the left so that it shows grey ().
 - **I/O Configuration**—Saves the changes you made to the channels at the time you ran the backup.
 - **Accounts**—The user IDs and passwords, plus the scope of each user ID’s access.
 - **Networking**—Saves all of the following:
 - Hostname
 - The settings for the Ethernet 0 (ETH0) and WiFi.
 - The settings for the OpenVPN Tunnel 0.
 - The settings for the Network Options (DNS server IP address(es) and domain name(s), gateway IP address, the DNS order, and the gateway order).

This also includes sensitive information like the WiFi SSID and pre-shared key, and the OpenVPN server login credentials. If you select this setting, it’s important that you apply your own security or encryption to the backup file to protect this information.
 - **Firewall**—The firewall settings you selected, as well as any rules you created.
 - **Time**—The time zone and time servers configurations.
 - **Node-RED**—Part of a Node-RED project can include a credentials file, which can contain sensitive information like user names, passwords, and security keys. It’s important that you apply your own security or encryption to the backup file to protect this information.

Remember that any nodes you installed (like Opto 22 nodes or nodes to access cloud services) are not included in the backup.
 - **MQTT/Sparkplug**—The information you entered or selected when you configured your *groov* RIO unit to work with Sparkplug.
 - **Client SSL Certificates**—The most recent SSL certificates you may have uploaded.
 - **User Files**—Only the first 10 MB of files you uploaded manually or were placed there by control programs. After you create the backup file, you can review the log file to see which user files were stored in the backup file and which were not.
 - **USB Settings**—The enable and automount settings you chose.
 - **Server SSL Certificates**—The server SSL certificates include sensitive information, like the web server’s private key. If you select this setting, it’s important that you apply your own security or encryption to the backup file to protect this information.
4. Click Download Backup.
5. Navigate to the folder or media where you want to store the backup file. *groov* Manage includes the date and time (in UTC) that you ran the backup as part of the file name. If you want to give it a different name, change the name in the File name field. Click Save.

NOTE: *Some browsers might automatically download the file to a specific folder. Check your browser’s downloads settings to determine where the browser stored the backup file.*

6. Opto 22 recommends that you apply some form of security on the backup file.
7. (Optional) To check which user files the backup may have missed, in *groov* Manage, click the menu button (), then select Info and Help. Click Logs > *groov* Manage.

Review the log file for the list of user files that were and were not included in the backup file. Look for lines like the following:

```

A [2020-04-16 21:58:31.498] [INFO] ComponentBackupRestore -
  Creating folder for User Files
[2020-04-16 21:58:31.503] [INFO] ComponentBackupRestore -
  Copying files for User Files
B [2020-04-16 21:58:31.521] [INFO] ComponentBackupRestore -
  Copying /home/dev/secured/logo-rio-red-grey-569x197.png
[2020-04-16 21:58:31.538] [INFO] ComponentBackupRestore -
  Copying /home/dev/secured/rio.txt
[2020-04-16 21:58:31.550] [INFO] ComponentBackupRestore -
  Copying /home/dev/secured/temperature_log-1.csv

```

A—These lines indicate that *groov* Manage started backing up user files.

B—This line indicates the first user file that *groov* Manage backed up.

8. Compare the list of files in the log with the list of files in the Internal Drive section of the Files page. (From the *groov* Manage Home page, click System > Files.) Note any differences and download those files.

RESTORING A BACKUP OR SPECIFIC SETTINGS FROM A BACKUP FILE



Here are a few reasons you might want to restore all or part of a backup:

- If you had to restore your processor to factory settings, a backup can help you quickly restore a previously-saved configuration.
- You might want to restore a prior configuration or a specific part of a prior configuration; for example, only the firewall settings.
- After you apply an update, restoring a backup can help you quickly restore a previously-saved configuration.

When you want to restore a backup file, remember the following:

- You can restore a subset of the settings stored in a backup file; for example, only the firewall and accounts.
- When you run the restore feature, the *groov* RIO shuts down all services and applications, restores the projects and settings, and then restarts RIO. So, make sure to schedule the restoration during a time that minimizes its impact on your applications and equipment.
- The user IDs and passwords that are restored do not include any user IDs that you created after you created the backup file. So, make sure you know the user ID and password of any administrator account saved in the backup file so you can use that ID and password when you log into *groov* RIO.

To restore a backup file or specific part of a backup file:

1. Locate the media or folder that contains the backup file and remove any security you may have applied to the file.
2. On a computer or mobile device that contains the folder or is connected to the medium that contains the backup file, log into your *groov* RIO with a user ID that has administrator privileges.
3. Click Maintenance > Restore.
4. In the Restore page, select or deselect the settings you want to restore. If you want to restore a particular set of settings, leave the slider green (). If you do not want to restore a particular set of settings, move the slider to the left so that it shows gray ().

NOTE: If you select a setting that doesn't contain any information in the backup, nothing will be restored for that setting. This can happen if:

RESTORING A BACKUP OR SPECIFIC SETTINGS FROM A BACKUP FILE

- When you created the backup, you deselected the setting.
- You select a setting (see below) that was not available in previous versions of the groov RIO firmware.

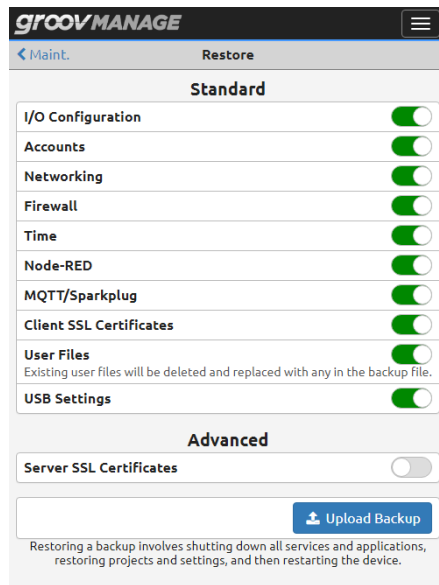

5. Click Upload Backup.
6. Navigate to the folder or media device that contains your backup file.
7. Click Open. *groov* Manage displays the following message, reminding you of what *groov* RIO will do during the restoration:

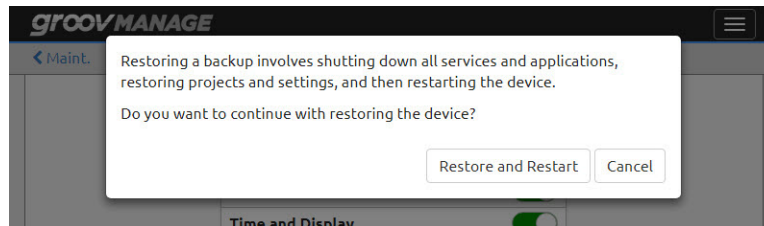

8. Click Restore and Restart. *groov* Manage displays a message that shows progress:

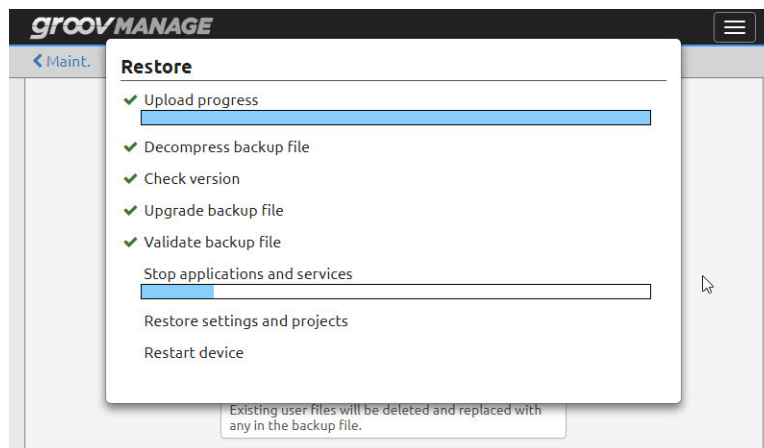

9. When the restoration is done, *groov* Manage shows you this message:

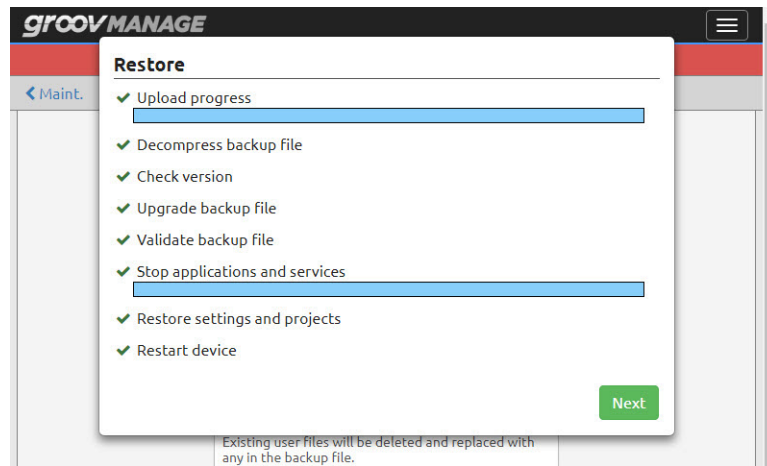

Click Next.

10. *groov* Manage shows you a message that gives you a few tips about what you might need to do next. Read the message and then click Close.

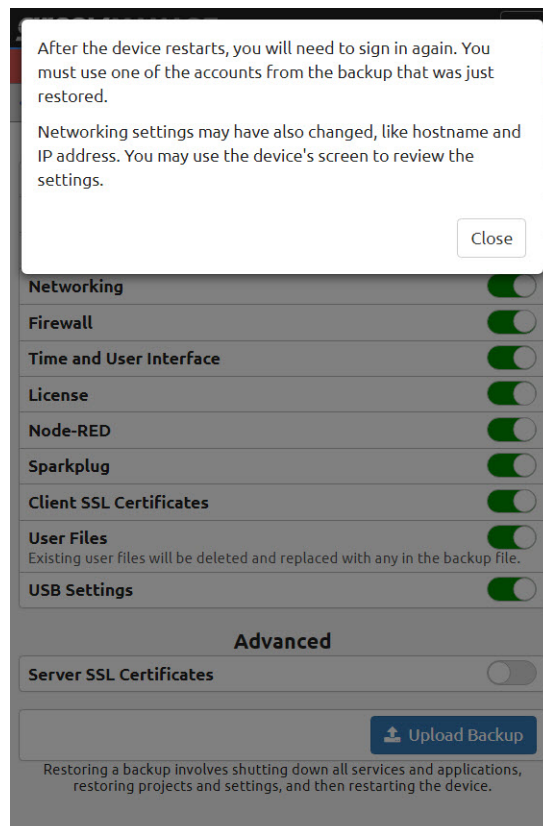

11. *groov* RIO restarts. Wait for the *groov* RIO login screen and log back in with any user ID that has administrator authority and was stored in the backup file.
12. Review the configuration settings for things like I/O, date and time, and network, to assess whether you need to make additional changes that were not stored in the backup file.
13. Because the backup files contain only the first 10 MB of user files, if there were any additional files that weren't included in those 10 MB, upload them.

UPDATING FIRMWARE ON A *groov* RIO

Updating firmware on a *groov* RIO keeps it up-to-date with the latest features and fixes. Updating firmware can take 20-30 minutes or more to complete and your *groov* RIO will be restarted, so schedule the update during a time when it minimizes impact to your automation processes and equipment. Remember that if you have several RIOs daisy-chained together, if you updated the firmware on one RIO, you must update the firmware on all the RIOs in the chain.

1. If you haven't done so recently, create a backup file (see "Backing up Your *groov* RIO Settings" on page 91). Keep this file handy and secure.

Note: groov Manage provides you the option to automatically create a backup before it installs the firmware. However, if you have an excess of 10 MB of user files, or you don't want certain settings saved in the backup, create a backup.

2. Log on to opto22.com and enter the part number for your *groov* RIO in the Search box. Select the search result that includes "Firmware" as part of the title; for example GRV-R7-MM1001-10 Firmware.
3. Click Download. Save the file to either:
 - A computer or mobile device that can connect to your *groov* RIO, or
 - Media that you can then install to a computer or mobile device that can connect to your *groov* RIO.
4. On the same computer or mobile device where you saved the firmware file, log into your *groov* RIO with a user ID that has administrator privileges.
5. From the *groov* Manage Home page, click Maintenance > Update.
6. On the Update page, decide:
 - If you want to save all your current settings and then have the *groov* RIO restore them after the restart, leave the Back Up Settings slider in the default position (the slider shows green). Leaving this setting on will also save you some steps later on.

If you created a backup file in step 1, note that the information in that backup file may not be the same as what groov Manage stores in the backup it creates as part of this step.

- If you *do not* want the settings saved and restored after the restart, move the slider to the left so that it shows gray (). You'll want to select this if you want to restore your *groov* RIO with settings from a different backup file; for example, the one you created in step 1.

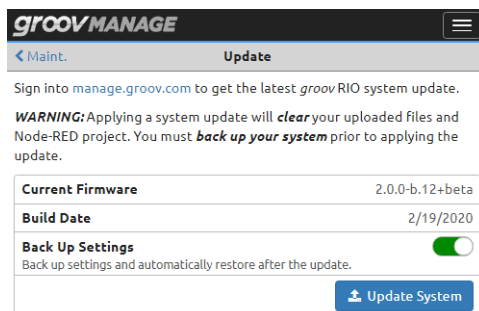

7. Click Update System.
8. Navigate to the software update file you downloaded in [step 3](#).
9. Click Open.

groov Manage displays a message to remind you that the update clears all your settings and projects, and gives you one more opportunity to cancel and perform that important backup.

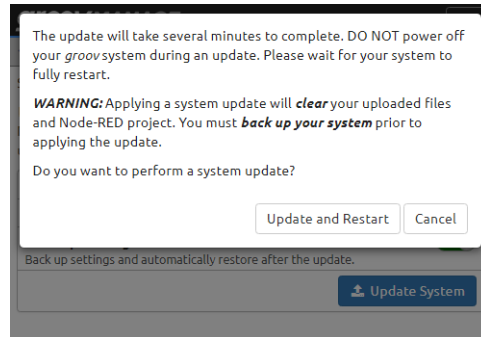

10. If you are ready to proceed with the update, click Update and Restart.
groov Manage displays an Update message, which shows you the progress of the update. The update can take several minutes to complete. During that time, the banner (in the background) changes color to yellow.

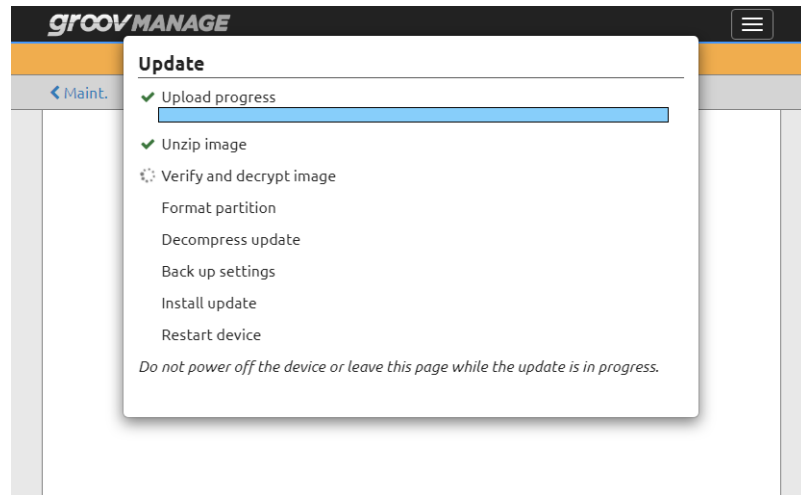

11. Watch for the banner to turn red, which indicates that the update is finished and *groov* RIO is now offline. Review the messages and then click Next.

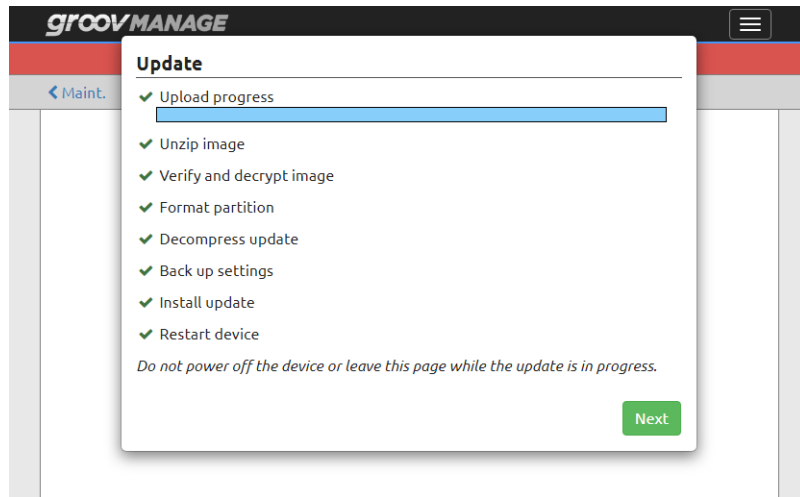

12. Read the instructions on what to do after *groov* RIO restarts, and then click Close.

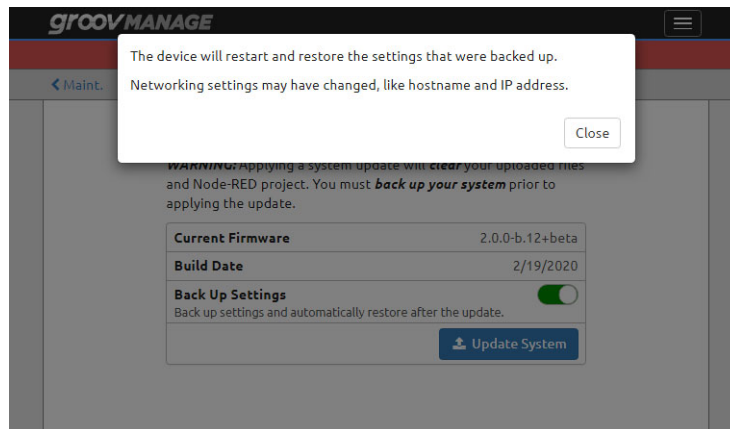

13. If you can see the *groov* RIO unit, monitor the STAT LED. When it shows solid green, the restart is finished and the browser refreshes. If you can't see the RIO unit, you will know that the restart is done when the browser refreshes.

Note: If the browser doesn't refresh after about 5 minutes, refresh it by pressing F5 or CTRL+R.

14. When the restart is done, you see one of the following screens.

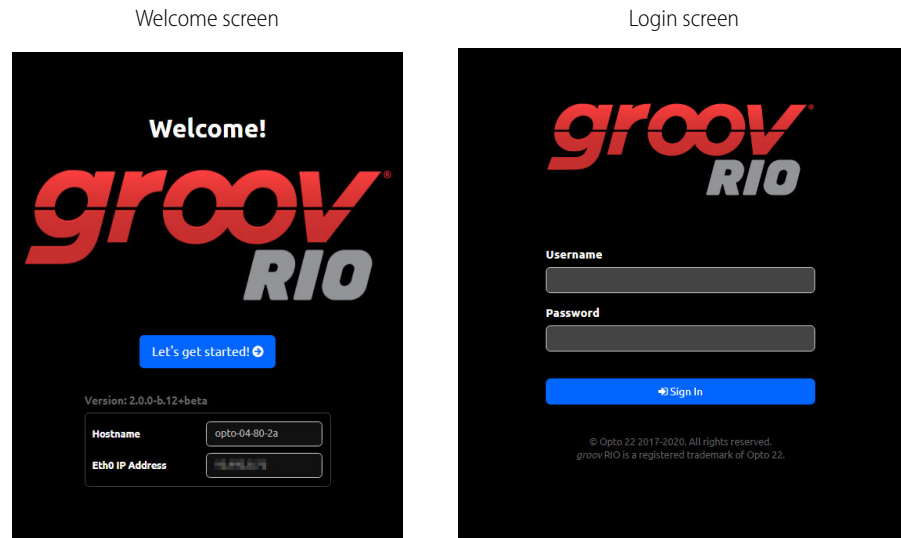

If you see the Welcome! screen (you'll see this screen if you **d**eselected the Back Up Settings option in [step 6](#) on [page 96](#)):

- Make a note of the IP address shown in the Eth0 IP Address box. You'll need it in the next few steps.
- Click Let's get started! and create an administrator user ID and password. (It does not have to match any that might be stored in a backup file; however, you still do have to remember to store it in a safe location for later recall.)
- Click on Configure Device.
- If you want to restore a backup file, do that now.

If you see the login screen (you'll see this screen if you selected the Back Up Settings option in [step 6](#) on [page 96](#)), log into your *groov* RIO with a user ID that has administrator privileges.

If you see neither screen (likely because your network settings were not backed up as part of the update), use *groov* Find to get the IP address or hostname of the unit. See "Downloading and Running *groov* Find" on [page 100](#).

15. If you were developing and running Node-RED flows, re-install any nodes required by your flows. For example, to re-install the Opto 22 nodes:
- Click the menu button () > Manage palette > Install tab.
 - Search for `node-red-contrib-pac`.
 - Click the small Install button.

Repeat the previous steps for any other nodes required by your flows.

If you do not re-install these nodes and you try to run your flows, you'll receive messages that your flows cannot run due to missing nodes.

TROUBLESHOOTING

Browser Reports that URL to RIO is Unreachable

There are several reasons that a browser may report that it cannot connect to your RIO through its hostname; some of those reasons may be physical connectivity issues, some may be network configuration issues. Here are a few things to check:

- Verify that the Ethernet cable that you inserted into the RIO's Ethernet port is connected to the network.
- Make sure the STAT LED is solid green before you attempt to connect to your RIO. (For a diagram that shows you where the STAT LED is located, see [page 8](#).)
- Check that the LED of the Ethernet port (ETH0 or ETH1) is showing link speed and activity. (For an explanation of LED activity, see [page 8](#).)
- If the RIO is connected to a network that does not automatically assign IP addresses to new devices (which typically means the network is not managed by a DHCP server), download *groov Find* to help you locate your *groov* RIO on your network (see below). You *must* use *groov Find* if your network does not have DNS.

Downloading and Running *groov Find*

groov Find is an application available on our website (for Windows PCs) or the Mac App Store (for Mac computers) that can help locate *groov* RIOs, *groov* EPICs, and *groov* Boxes on your network.

Instructions for PC Users:

1. [Download *groov Find* from our website](#) (go to www.opto22.com and enter `groov Find` in the search box). Save the file to your computer.
2. Open the Find application file.

If you have User Account Control (UAC) turned on, a message appears asking if you want *groov Find* to be allowed to make changes to your computer.

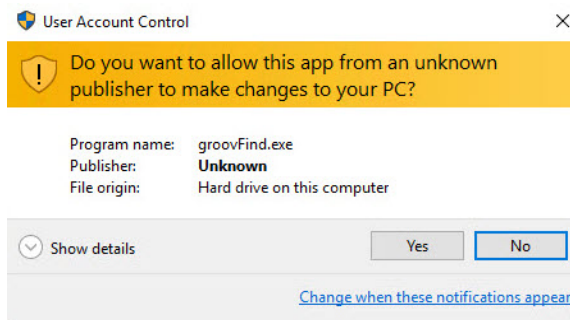

*NOTE 1: If you are using a Windows account that does not have Administrator privileges (such as Guest), you will need to enter the Administrator User Name and Password in order to use *groov Find*. If you do not have this information, contact your IT department.*

*NOTE 2: Clicking Yes permits Find to have temporary administrative privileges to create an additional temporary IP address for each network interface on the computer. This enables Find to locate a *groov* device on a network that does not have DNS and DHCP. If the network does not have DNS and DHCP, you will need to assign a static IP address to the *groov* device in order to maintain communication. If the network does have DNS and DHCP, the temporary IP address is not used and is removed when you exit Find.*

3. Click Yes.
groov Find opens and automatically searches for *groov* RIOs, *groov* EPICs, and *groov* Boxes on the network.
4. Locate the serial number on the *groov* device.
 - On *groov* EPIC, open the LCD display and look at the label on the back of the display.
 - On a *groov* Box, find the label on the bottom of the Box.
 - On a *groov* RIO unit, the label is on the unit's side. The serial number is indicated by SN.

- Locate the matching serial number in Find.

Device Type	Serial Number	Hostname	IP Address	Open in browser...
GROOV-AT1	11111111	opto-11111111	192.168.1.111	groov Admin groov View
GROOV-AR1	22222222	opto-22222222	192.168.1.222	groov Admin groov View
GROOV-AR1	33333333	opto-33333333	192.168.1.333	groov Admin groov View
GROOV-AT1	44444444	opto-44444444	192.168.1.444	Click to start groov
GROOV-AT1	55555555	opto-55555555	192.168.1.555	Click to start groov
GRV-R7-MM1001-10	66666666	opto-66666666	192.168.1.666	Click to start groov Manage
GRV-R7-MM1001-10	77777777	opto-77777777	192.168.1.777	Click to start groov Manage
GRV-EPIC-PR1	88888888		192.168.1.888	Click to start groov Manage
GRV-R7-MM1001-10	99999999	opto-99999999	192.168.1.999	Click to start groov Manage
GRV-R7-MM1001-10	00000000	RIO-00000000	192.168.1.000	Click to start groov Manage
GRV-R7-MM1001-10	11111111	rio-11111111	192.168.1.111	Click to start groov Manage

Note: If your device was not found, wait 60 seconds and try again. [more info](#)

If you do not see the serial number right away, wait 60 seconds and click Search For Devices.

- Click the link for *groov* Manage.

Instructions for Macs:

- Locate the serial number on the *groov* device.
 - On *groov* EPIC, open the LCD display and look at the label on the back of the display.
 - On a *groov* Box, find the label on the bottom of the Box.
 - On a *groov* RIO, the label is on the unit's side. The serial number is indicated by SN.
- On your Mac, go to the Mac App Store.
 - Click on the apple menu (top left corner), then select App Store.
 - Click on Finder, then click Applications, then find and click App Store.
- In the store, enter `opto 22` in the search box.
- Click "Get" on the *groov* Find app. If requested, enter your Apple Store ID and password.
- Click Open to start the *groov* Find app. Within a few moments, *groov* Find begins locating *groov* RIOs, *groov* EPICs, and *groov* Boxes on your network and displays them in a list.
- Under the Serial Number column, locate the serial number of your *groov* device and select it.
- At the bottom of the window, click either Open *groov* View or Open *groov* Manage. Your default browser will open up with the *groov* device's IP address in the URL bar, and then load either *groov* View or *groov* Manage.

CODESYS: "Invalid Channel Type. Module or channel may not be compatible."

There are certain combinations of signal types that aren't supported on GRV-R7-MM1001-10. CODESYS does not prevent you from creating these combinations, so you might not know you created one until you try to

RESETTING TO FACTORY DEFAULTS

download your project. When this happens, you'll see the following messages on the channels that are incorrectly configured:

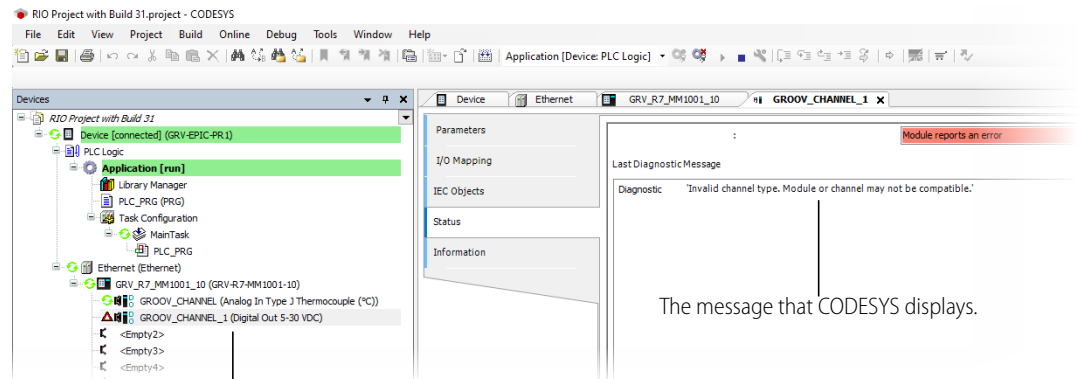

A GRV-R7-MM1001-10 with an unsupported combination of signal types on channels 0 & 1.

To correct this problem, move the problematic signal type to a channel further away. In this example, we move the digital sinking output from channel 1 to channel 7:

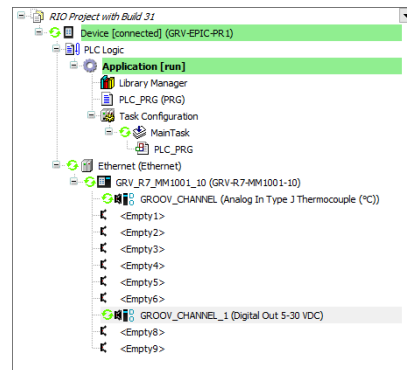

RESETTING TO FACTORY DEFAULTS

You might have to reset to factory defaults if instructed to do so by product support. A reset to factory defaults erases all the changes you made to the *groov* RIO, which is why it is important that you regularly back up your system. (For instructions, see “[Backing up Your groov RIO Settings](#)” on page 91.)

Insert a paper clip into the RST hole and push down for approximately 8 seconds. Release the button when the STAT LED alternates between red and green.

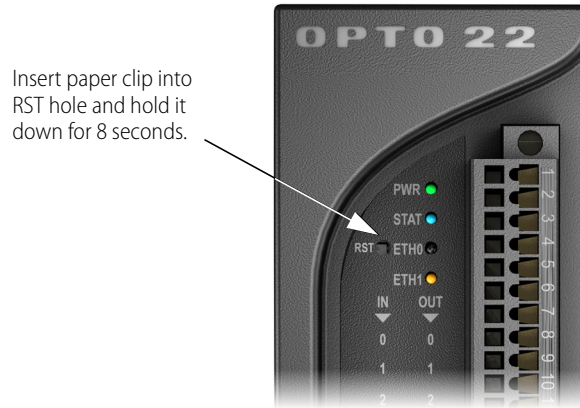

Insert paper clip into RST hole and hold it down for 8 seconds.

COLLECTING INFORMATION FOR PRODUCT SUPPORT

The *groov* RIO collects information in several logs that can help Product Support diagnose and solve issues. Product Support will direct you with the specific information to collect. You might want to create a new folder on your computer or mobile device with the name of the Opto 22 ticket number, if you have one, and store all this information into that folder.

If you need to collect information from the screens, you can use the screen capture feature on the computer or mobile device to save (capture) the screens.

If Product Support directs you to send log files, do the following steps:

1. On a computer or mobile device, log into the *groov* RIO with a user ID that has administrator privileges.
2. Click Info and Help.
3. Click Logs.
4. Click on the specific log or logs as directed by Product Support.
5. Click Download.
6. Navigate to a folder on your computer or mobile device where you want to save the log. You might also want to make note of the name of the log file or modify it to something else.
7. Click Save.
8. Repeat steps 4 through 7 for all the logs that Product Support directs you to download.

Send this information to Opto 22 as directed by Product Support.

CONDUCTING AN OPTOSUPPORT REMOTE SUPPORT SERVICE (RSS) SESSION

An OptoSupport Remote Support Service (RSS) session can help expedite the resolution of your support ticket by allowing the OptoSupport team member to remotely connect to your *groov* RIO to continue with diagnostics and troubleshooting.

After evaluating the progress of your ticket, your Opto 22 Support team member might determine that your situation would benefit from an RSS session and discuss with you the benefits and goals of the session. If you agree with this step, our team member will schedule a time to start a Remote Support Service (RSS) session.

Before beginning the session, make sure your *groov* RIO is on a network with access to the Internet.

An RSS session typically runs like this:

1. At a time agreed upon by you and your OptoSupport team member, you'll initiate a phone call.

CONDUCTING AN OPTOSUPPORT REMOTE SUPPORT SERVICE (RSS) SESSION

2. When instructed, click Create RSC to initiate the session. For detailed instructions and an explanation of what happens during this step, see [“Initiating an RSS Session” on page 104](#).
3. After the session is successfully created, you and your OptoSupport team member will review details of your situation and discuss additional steps. These steps might be:
 - Continue active discussion of the problem over the phone while the OptoSupport team member diagnosis and troubleshoots your *groov* RIO.
 - Agree to a plan of action where you can end the phone call while the OptoSupport team member continues to diagnose and troubleshoot your RIO.

If the session is lengthy, part of the plan might include pausing the session and continuing it at a later time. For additional instructions on pausing and resuming a session, see [“Pausing and Resuming an RSS Session” on page 105](#).

4. When it's time to end the RSS session, click Delete RSC. For important information on what happens when you end an RSS session, see [“Ending the RSS Session” on page 106](#)

Initiating an RSS Session

1. The Opto 22 Support team member will ask you to navigate to the OptoSupport RSS page, if you haven't already done so. (From the *groov* Manage home page, click or tap Info and Help > OptoSupport RSS.)
2. The Opto 22 Support team member will ask for the serial number listed on the OptoSupport RSS page. This information is necessary for the connection to be successful.

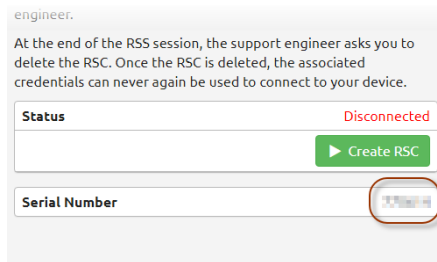

3. When instructed by the Opto 22 Support team member, click Create RSC. The first thing you see is the OptoSupport Remote Support Service Permission and Release Agreement. To proceed with the session, accept the agreement.
4. After you click Accept, *groov* Manage displays a message to indicate the progress of establishing the connection before it starts a connection:

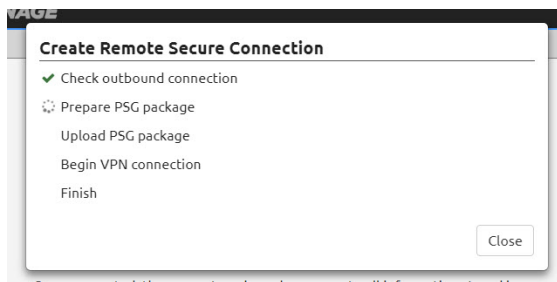

5. When it finishes these steps, click OK to close the message box:

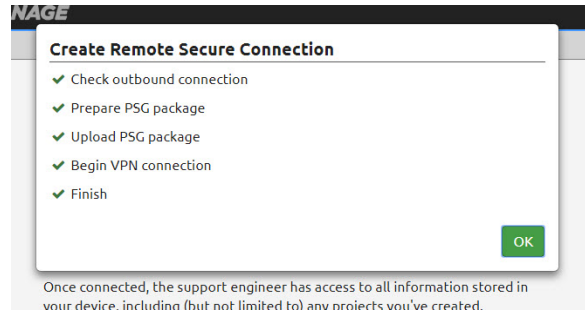

- While your *groov* RIO is trying to connect, you see this message on the OptoSupport RSS page:



- After the connection is established, you see this message on the OptoSupport RSS page:



Do not turn off your *groov* RIO after you start the session, or you will need to start this process over.

Pausing and Resuming an RSS Session

During the course of diagnosis and troubleshooting, you and your OptoSupport team member might agree to pause the session, then resume it at a later time. Pausing the session prevents communication between OptoSupport team member and your *groov* RIO while preserving the information needed to quickly resume the connection.

- To pause a session, click Pause in the OptoSupport RSS page (Info and Help > OptoSupport RSS). *groov* Manage displays a message confirming the pause. Click OK to close the message. The OptoSupport RSS page updates the status to indicate the RSS session is paused:



- To resume a session, click Continue RSC in the OptoSupport RSS page (Info and Help > OptoSupport RSS). After the connection is re-established, the OptoSupport RSS page displays the status as Connected.



Ending the RSS Session

When it's time to end the RSS session, click Delete RSC in the OptoSupport RSS page (Info and Help > OptoSupport RSS). All of the information that your *groov* RIO created to establish the connection will be erased. If you need to start another RSS session, you'll need to start from the first step in ["Initiating an RSS Session"](#) on page 104.

A: Specifications

GRV-R7-MM1001-10

You can configure the GRV-R7-MM1001-10 (a multi-signal, multifunction edge I/O unit) with any combination of the following inputs and outputs:

- Up to 2 electromechanical relays
- A combination of up to 8:
 - discrete or analog inputs
 - discrete or analog outputs

Features are listed on the next page; specifications are listed in the page that follows.

Features

GRV-R7-MM1001-10		Signal Type					
	DI: • Discrete • Switch Input, Powered	DI: • Discrete • Switch Input, Powered	DO: • DC Sinking	DO: • Form C Mech. Relay	AI: • Voltage • ICTD	AI: • Current • Thermocouple • Millivolt	AO: • Voltage • Current
Channels	0-1	2-7	0-7	8-9	0-7	0-3	4-7
Features							
On/off State	x	x	x	x			
On/off Latching	x						
Counting	x						
On/off Totalization	x						
Frequency Measurement	x						
Period Measurement	x						
Pulse Measurement	x						
Scaling					x	x	x
Offset and Gain					x	x	
Minimum/Maximum Values					x	x	
Average Filter Weight					x	x	
Simple Moving Average							
Analog Totalizing					x	x	
Output Pulsing / TPO			x				
Ramping							x
Clamping							x
Watchdog Timeout Value			x	x			x
Quality Indication					x	x	x

Specifications

Specification	GRV-R7-MM1001-10
Voltage Input	
Available Channels	0–7
Input Range	0–10 V DC
Over-range Limit	0–11 V DC
Resolution	0.5 mV
Accuracy	±0.05% of range (±5 mV)
Gain Temperature Coefficient	30 ppm/°C
Offset Temperature Coefficient	15 ppm/°C
Input Impedance	> 425 kOhms
Data Refresh Time	450 ms
50 / 60 Hz rejection	> 90 dB
Current Input	
Available Channels	0–3
Input Range	0–20 mA
Over-range Limit	20.8 mA
Recommended Fuse	32–40 mA, Fast Acting (for example, Eaton S500-32-R)
Resolution	1.0 µA
Accuracy	±0.05% (±10 µA)
Gain Temperature Coefficient	30 ppm/°C
Offset Temperature Coefficient	15 ppm/°C
Input Voltage Drop (±10%)	0.9 V @ 4 mA, 2.0 V @ 20 mA, 25 °C
Equivalent Input Impedance (±10%)	225 Ohms @ 4 mA, 100 Ohms @ 20 mA, 25 °C
Data Refresh Time	450 ms
50 / 60 Hz rejection	> 90 dB
ICTD Input	
Available Channels	0–7
Input Range with ICTD Probe	-40 to +100 °C
Resolution	0.04 °C
Accuracy with ICTD Probe	±1.0 °C (1.8 °F)
Gain Temperature Coefficient	30 ppm/°C
Offset Temperature Coefficient	60 ppm/°C
Data Refresh Time	450 ms
50 / 60 Hz rejection	> 90 dB

Specification	GRV-R7-MM1001-10
Thermocouple Input	
Available Channels	0–3 *
Nominal Input Range	-75 to +75 mV
Full Scale Range	-78 to +78 mV
Input Resolution	3 microvolts
Input Impedance	> 1 megohm
Data Refresh Time	450 ms all channels
50 / 60 Hz rejection	> 90 dB
Thermocouple ITS90 Types	± Accuracy / Resolution
B: 90 °C to 1,820 °C	7 °C / 0.4 °C
E: -80 °C to 1,000 °C	2 °C / 0.1 °C
J: -100 °C to 1,200 °C	2 °C / 0.1 °C
K: -80 °C to 1,372 °C	2 °C / 0.1 °C
N: -100 °C to 1,300 °C	3 °C / 0.1 °C
R: 100 °C to 1,768 °C	6 °C / 0.3 °C
S: 100 °C to 1,768 °C	6 °C / 0.3 °C
T: -60 °C to 400 °C	3 °C / 0.1 °C
* Note: To achieve the best thermocouple accuracy when also using current outputs or discrete outputs, always configure thermocouples on the lowest channel numbers and outputs on the highest channel numbers.	
Millivolt Input	
Available Channels	0–3
Input Range	-150 to +150 mV
Over-range Limits	±165.0 mV
Resolution	10 µV
Accuracy	±0.1% of Range (±150 µV)
Input Impedance	> 1 MOhms
Data Refresh Time	450 ms
50 / 60 Hz rejection	> 90 dB
Discrete DC Input	
Available Channels	0–7
Input Voltage Range	5–30 V DC
Minimum ON Voltage	5.0 V
Maximum OFF Voltage	1.5 V
Input Impedance	> 425 KOhms
Max. Input Frequency (50% square wave)	10000 Hz

Specification	GRV-R7-MM1001-10
Switch Input, Powered	
Available Channels	0–7
Open Circuit Voltage (Switch Open)	10.5 V (minimum)
Channel Current Limit	1.1 mA max.
Channel Operating Current	0.63 mA typical
Minimum Off Resistance	3300 Ohms
Maximum On Resistance	1200 Ohms
Minimum ON Voltage	5 V
Maximum OFF Voltage	1.5 V
Maximum Continuous Survivable Input Voltage	32 V
Input Impedance	> 425 KOhms
Max. Freq. (50% square wave)	10000 Hz
Discrete Counter Input	
Available Channels	0–1
Input Voltage Range	5–30 V DC
'ON' Threshold	5 V
'OFF' Threshold	1.5 V
Input Impedance	> 425 KOhms
Max. Frequency (50% square wave): State, Latches, Counter	10000 Hz
Max. Frequency (50% square wave): On/Off pulse width, Period, Frequency	2000 Hz
Max. Frequency (50% square wave): On/Off totalization	750 Hz
Pulse Width Measurement Resolution	100 microseconds
Pulse Width Measurement Error (50% square wave)	0.1% 0 to 20 Hz. 1% 21 to 200 Hz. 5% 201 to 2000 Hz.
Period/Frequency Error (50% square wave)	0.05% 0 to 20 Hz. 0.1% 21 to 200 Hz. 1% 201 to 2000 Hz.
Discrete DC Sinking Output	
Available Channels	0–7 (4-7 if using any thermocouple inputs)
Line Voltage Range	5–30 V DC
Maximum Continuous Current	1.0 A
Peak Current (< 10 ms)	4.0 A
Recommended Fuse / Circuit Breaker	1 A at 30 V DC
Output Voltage Drop	175 mV at 1 A
Off-State Leakage (per channel)	< 80 μ A at 24 V, -20 to +70 °C
Peak Blocking Voltage	32 V
TPO Period (min, max, resolution)	0.004, 4294967, 0.001
Turn On / Off Time	20 ms nominal.

Specification	GRV-R7-MM1001-10
Form C Relay Output	
Available Channels	8, 9
Line Voltage Range	0–250 V AC or 5–30 V DC
Clamp Voltage	440 V nominal
Current Rating	5 A per channel
Surge Current	6 A peak for 1 second
Recommended Fuse / Circuit Breaker	5 A at 250 V AC / > 30 V DC per channel
Initial Contact Resistance	< 100 milliohms
Turn On Time	8 ms
Turn Off Time	4 ms
Operating Life (to specification)	Min. 30,000 cycles at max. ratings
Mechanical Life	Min. 10,000,000 cycles
Voltage Output	
Available Channels	4–7
Range	0–10 V
Resolution	2.5 mV
Accuracy	±0.2% of range (±20 mV)
Gain Temperature Coefficient	50 ppm/°C
Offset Temperature Coefficient	20 ppm/°C
Output Slew Rate	> 15 V/ms
Minimum Load Resistance	7.5 kOhms
Output Impedance	< 10 Ohms
Short-circuit Current	20 mA
Data Refresh Time	Nominal 20 ms. Proportional to I/O scan time.
Current Output	
Available Channels	4–7
Output Range	0–20 mA
Resolution	5 µA
Accuracy	±0.25% of range (±50 µA)
Gain Temperature Coefficient	60 ppm/°C
Output Slew Rate	> 10 mA/ms
Maximum Loop Resistance	700 Ohms
Data Refresh Time	Nominal 20 ms. Proportional to I/O scan time.

Specification	GRV-R7-MM1001-10
Common Specifications	
Ethernet	Two switched Gigabit ports; daisy-chainable; ETH1 with 802.3af PoE powered device (PD)
USB	One Port, USB 2.0 HS
Memory	1 GB RAM, 2.5 GB user space
Power Supply	802.3af PoE Class 0 or 10–32 V DC
Power Consumption	10 W
Max. Survivable Input (channels 0 - 7)	32 V DC
Isolation (between channels 0 - 7)	None
Isolation (between channel 8 or 9 and all others)	3000 V AC _{rms} 1 min.
Isolation (field to Ethernet / power input)	1500 V AC _{rms} 1 min.
Minimum GRV-EPIC-PR1 Firmware Version	2.0.0
Minimum PAC Project Version	10.3000
Minimum Library Package for CODESYS Version	2.0.0.0
Field Connector Wire Size	28–14 AWG
Torque, field connector screw	2.5 in-lb (0.28 N-m)
Power Connector Wire Size	22–14 AWG
Torque, DC power connector screws	7.0 in-lb (0.79 N-m)
Torque, panel mount tab screw	2.0 in-lb (0.23 N-m)
Temperature (operating)	-20 °C to +70 °C
Temperature (storage)	-40 °C to +85 °C
Relative Humidity (non-condensing)	5–95%
Agency Approvals	UL/cUL(Class 1 Div. 2); CE, ATEX(Category 3, Zone 2), RoHS; DFARS; CB Scheme
Warranty	30 months

Wiring Assignments

These assignments apply to the thermocouple input signal type.

Type	-	+	Range
B	Red	Gray	+90 °C to +1,820 °C
E	Red	Purple	-80 °C to +1,000 °C
J	Red	White	-100 °C to +1,200 °C
K	Red	Yellow	-80 °C to +1,372 °C
N	Red	Orange	-100 °C to +1,300 °C
R,S	Red	Black	100 °C to +1,768 °C
T	Red	Blue	-60 °C to +400 °C

B: Wiring Diagrams

WIRING FIELD DEVICES

Diagrams are readily available to help you wire field devices to *groov* RIO.

- Basic wiring diagrams are shown on the following page for all channels. Note instructions on fusing and power.
- You can also find wiring diagrams for each channel type in *groov* Manage. At the *groov* Manage homepage, choose I/O Reference > *groov* RIO Mixed Signal, Multifunction > [RIO part number] and select the signal type to see how to wire it.

groov RIO Explorer

The *groov* RIO Explorer is an online, interactive tool that can help you select and track which combinations of functions (input or output) and signal types (analog, discrete, voltage, current, ICTD, thermocouple, etc.) you can assign to specific channels.

For instructions on how to use it, see [Appendix C: *groov* RIO Explorer](#) on page 117.

Channel	Internal Wiring	Pin	INPUT					OUTPUT				
			Discrete		Analog			Discrete	Analog	Mechanical Relay		
			Discrete	Switch Input, Powered	Voltage	Current ²	ICTD	Thermocouple/Millivolt	DC Sinking ¹	Current / Voltage	Form C-NO ¹	Form C-NC ¹
Ch 0		1										
	2											
		3										
Ch 1		4										
	5											
		6										
Ch 2		7										
	8											
		9										
Ch 3		10										
	11											
		12										
Ch 4		13										
	14											
Ch 5		15										
	16											
Ch 6		17										
	18											
Ch 7		19										
	20											
Ch 8		21									- NC	
		22										- COM
		23										- NO
Ch 9		24										- NC
		25										- COM
		26										- NO

Notes:

1. You must supply external fusing.
2. Opto 22 recommends adding external fusing. Review the specification table for specific ratings. Compatible with an externally powered or self powered transmitter. Wiring for externally powered transmitter is shown on channels 0 and 1. Wiring for a self powered transmitter is shown on channels 2 and 3.
3. Thermocouple inputs and discrete sinking outputs cannot be mixed on channels 0-3.

Review the notes along the bottom of the wiring diagram for additional instructions on fusing, power, and selecting supported combinations of signals for some channels.

C: *groov* RIO Explorer

The *groov* RIO Explorer is an online app that helps you see different combinations and arrangements of channel configurations and their associated wiring diagrams. With the app, you can:

- Identify which channels support a specific combination of function (input or output) and signal type (analog, discrete, voltage, current, ICTD, thermocouple, etc.).
- Move any signal that you placed on one channel to another supported channel.
- Avoid assigning a combination of function and signal type to a channel that does not support that particular combination.
- See a wiring diagram of the combination you built, plus different ways to arrange that combination.
- Export or import a combination into text description.
- See samples of wiring configurations from over 61,000 possible combinations.

THE *groov* RIO EXPLORER

Open the online app by opening a browser and going to www.opto22.com/products/groov-RIO-Explorer. Here's an overview of what you can see and do in the window:

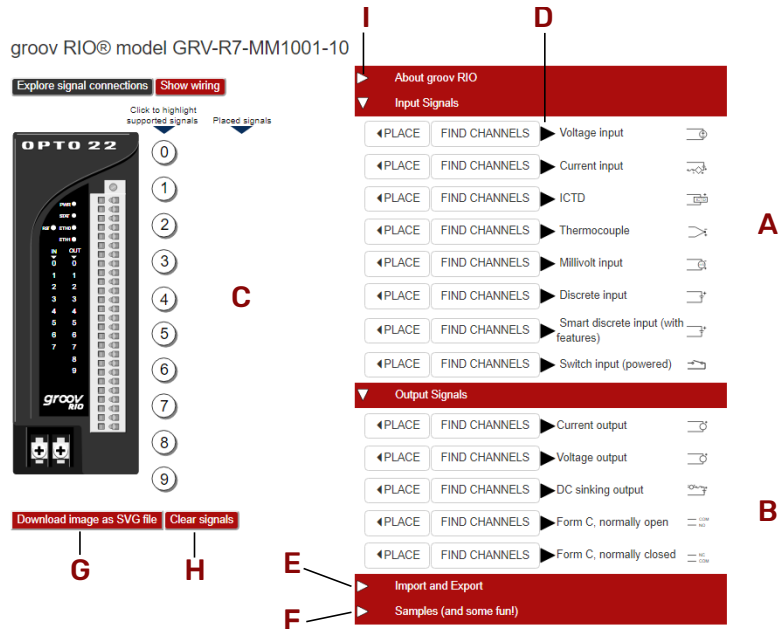

- A** Signal types available for inputs.
- B** Signal types available for outputs.
- C** When you place a signal, it's shown in this column, next to the channel you selected or the first channel number that supports that signal.
- D** To view specifications for the signal type, click the triangle next to it.
- E** To access import and export functions, click the triangle to open this section.
- F** To see sample configurations and different arrangements for your own or sample configurations, click the triangle.
- G** To download your wiring diagram as a Scalable Vector Graphic, click Download image as SVG file.
- H** To remove all the signals you placed on the RIO Explorer and start over, click Clear signals.
- I** To see specifications for this *groov* RIO unit, click the triangle.

Now let's see how to assign channels to match the configuration you want.

Assigning Functions and Signals to a Channel

Follow the steps below to assign a function (input or output) and signal type to a channel.

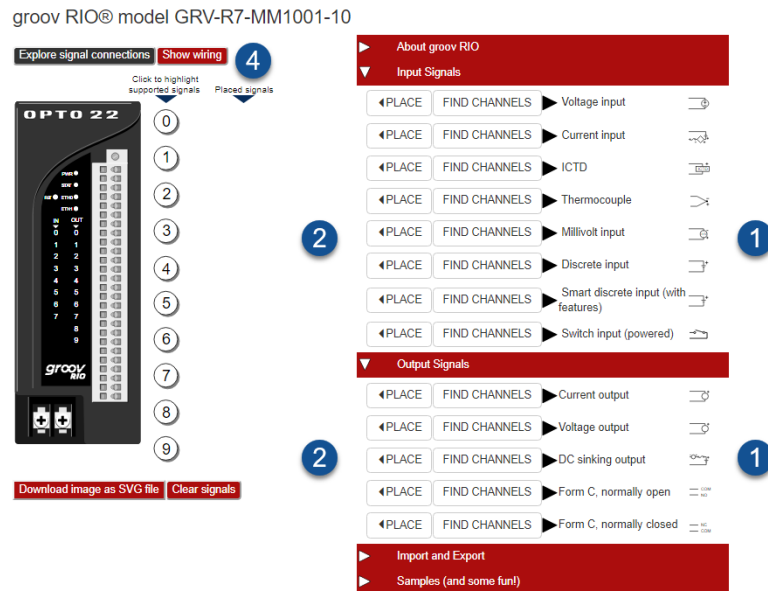

1. Look through the options on the right. Look in either the input or the output list and choose the signal type you need.

For example, if you need an ICTD input, look in the Input Signals list and find ICTD. If you need a voltage output, look in the Output Signals list and find Voltage Output.

2. Click Place next to the function and signal type you need.

The Explorer places that function and signal on a channel that supports that combination. For example, your ICTD input might appear like this:

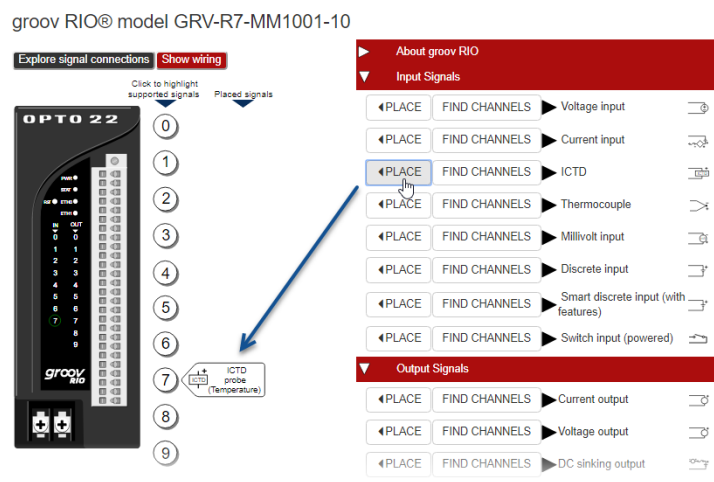

If you don't like where the Explorer placed your signal, see "Moving and Deleting Signals" on page 120.

- Repeat the previous steps for each additional channel you want to configure.

The Explorer will not let you place functions and signals into channels that don't support them.

- Click Show wiring to see a diagram that illustrates wiring for all your selections.

Below are three examples of images of wiring diagrams created by the *groov* RIO Explorer for function and signal type assignments made to channels on a GRV-R7-MM1001-10.

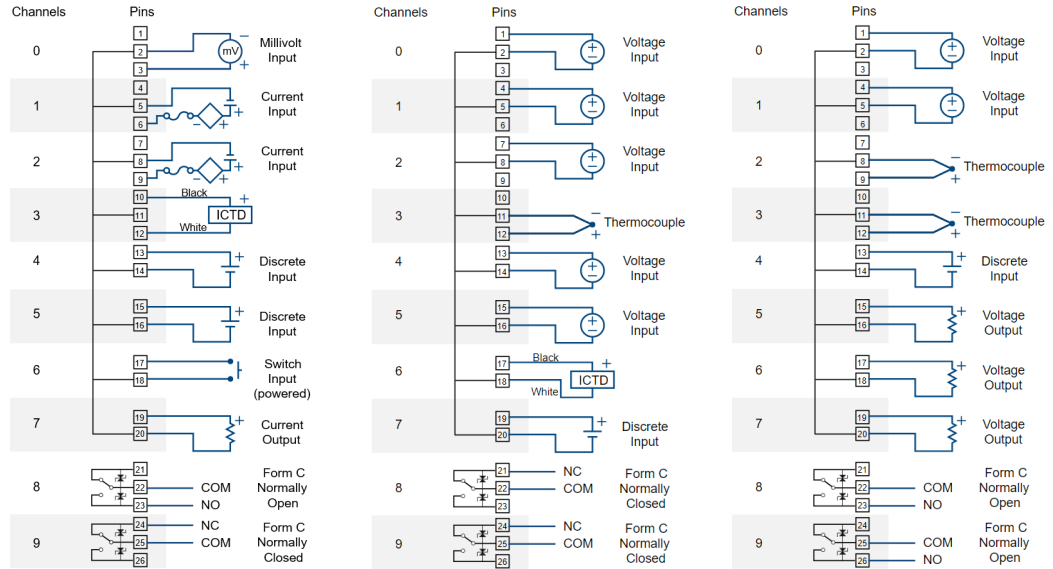

- If you want to save your wiring diagram as a re-sizable image file, click Download image as SVG file. To leave the wiring diagram, click Explore signal connections.

Moving and Deleting Signals

- To move a signal, click on the placed signal. Click the up or down arrow to move the signal to another available channel that supports that signal. (The Explorer can "hop" over assigned channels, if necessary.)
- To delete the signal, click a placed signal and then click Remove.

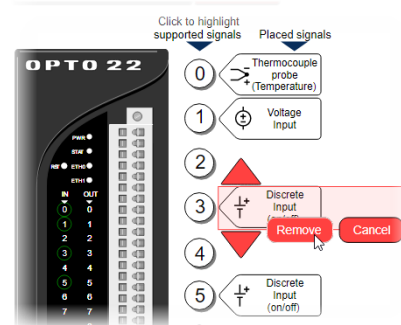

Viewing Possible Signals and Channels

To see which functions and signals you can place on a channel, click the channel number. The RIO Explorer highlights all the functions and signal types that you can assign to that channel.

In the example that follows, when you click the number for channel 5, the RIO Explorer highlights Voltage input, ICTD, Discrete input, and Switch input (powered) under the Input Signals section; Current output, Voltage output, and DC sinking output under the Output Signals section. You can assign any of those to channel 5.

groov RIO® model GRV-R7-MM1001-10

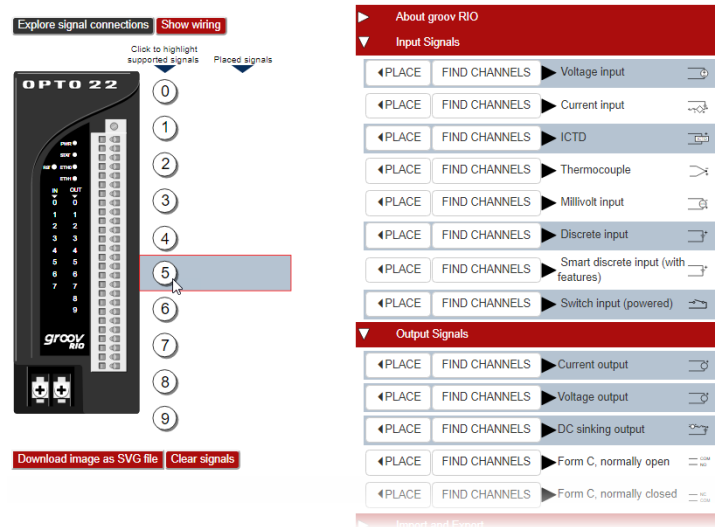

To see which channels can be configured with a specific function and signal, find the function and signal in the lists at right. Click the FIND CHANNELS button, and the Explorer highlights the channels that support that combination.

For example, if you want to see which channels will accept a smart discrete input with features like counting, latching, and totalization, click its Find Channels button. Channels 0 and 1 are highlighted, so you can place that signal on either (or both) of those channels.

groov RIO® model GRV-R7-MM1001-10

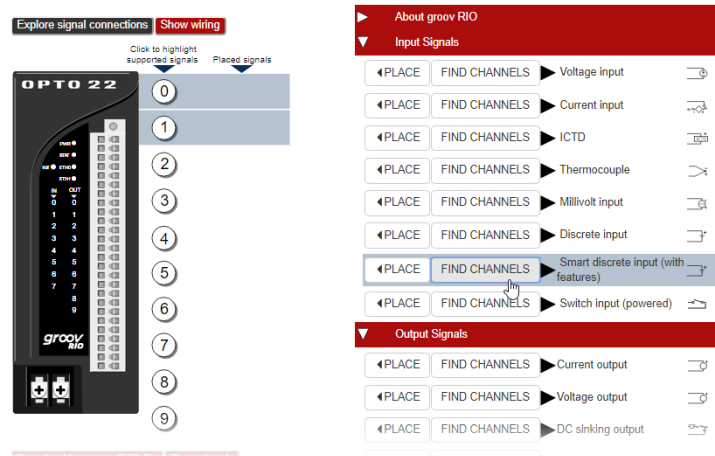

Replacing a Signal

1. Click the placed signal.
2. On the right side of the Explorer, find your new function and signal type.

3. Click Place next to the new signal.

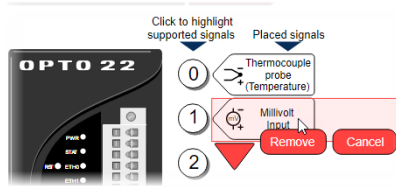

4. Click Replace.

EXPORTING AND IMPORTING COMBINATIONS OF FUNCTIONS AND SIGNALS

Once you have your *groov* RIO configured in the Explorer, you may want to save the signal combination by exporting it to a text file. Exported configurations can be imported later to view or work on.

Exporting

1. To export a combination, click Import and Export to expand that section.
2. Click Get Description.
The Explorer places abbreviations for the functions and signal types in the text box. (See below for the abbreviations used.)
3. Copy the text, paste it into a text file, and save it.



The following abbreviations identify functions and signal types:

Inputs	Outputs
ai_voltage	ao_current
ai_mv	ao_voltage
ai_current	do_sinking
ai_ictd	do_formc_no
ai_thermocouple	do_formc_nc
di_discrete	
di_smart_discrete	
di_switch_powered	

- **ai**—analog input
- **ao**—analog output
- **di**—discrete input
- **do**—discrete output

Importing

1. To import a combination, click Import and Export to expand the section.
2. Paste all the text from the text file you saved into the box. Click Import Configuration.

The RIO Explorer assigns the functions and signals to the channels, verifying that they are correct. There may be a delay while verifying.

Note that the channels may not end up in the same order you originally configured.

You can also type function/signal abbreviations into the field, and the Explorer will place them. It uses the first eight valid signals for channels 0-7 and the first two for channels 8 and 9. (Any text not in the correct abbreviation format is ignored.) So for example, to import channel assignments like the first wiring diagram on [page 120](#), you could type the following into the text box:

```
ai_mv,ai_current,ai_current,ai_ictd,di_discrete,di_discrete,
di_switch_powered,ao_current,do_formc_no,do_formc_nc
```

WORKING WITH SAMPLES

The *groov* RIO Explorer comes loaded with 61,260 wiring combinations! To access those samples, click Samples (and some fun!) to expand that section.

▼ **Samples (and some fun!)**

Here is a sample configuration using a practical mix of signals:

To see any of the 61260 wiring possibilities, select or enter a value from 0 to 61259:

Most combination of signals on a groov RIO can be rearranged using the same signals but changing the channel placement.

To have the alternative arrangements calculated, choose this button.

(Expect a delay while arrangements are calculated.)

Arrangements: ▼

One sample in particular can give you a good idea of the versatility of GRV-R7-MM1001-10. To see it, click Load Sample Configuration. The Explorer replaces any signals in the Placed signals area with the signals that are in the sample configuration.

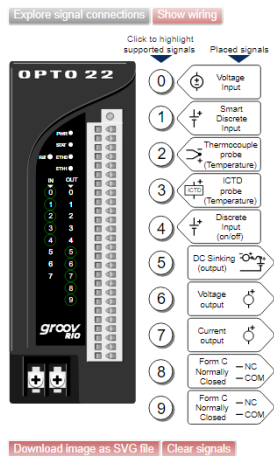

Samples are numbered 0 to 61259. Type in any number in that range in the text box, then click Load Combination to view that sample configuration. Have some fun with the numbers: enter a special date, the final score of your favorite football game, or the altitude of your favorite mountain.

How many ways are there to wire the same combination of functions and signals? For many samples or even for a configuration that you created, the arrangement of functions and signals on the channels can be changed. Seeing another way to wire the same signals can be useful if you have space constraints. The *groov* RIO Explorer can calculate the number of ways a particular combination can be rearranged. To learn that number and view the arrangements, click Calculate Arrangements for this Combination.

The RIO Explorer displays the result along with a drop-down list. Click the drop-down list and select any number, and the Explorer shows that arrangement. You can scroll through the numbers by pressing the up and down arrows on the keyboard. You'll see the Explorer update the image with each new arrangement.